



# PHOTON ENERGY SYSTEMS LIMITED

Mono - Crystalline

Series: PMM0225-0240-60

☎ 1800 4252 786

 [www.fb.com/PhotonSolarPower](http://www.fb.com/PhotonSolarPower)



## ABOUT

Established in 1995, Photon Energy Systems Limited is one of the most experienced solar energy companies in the World. At Photon, we are the leading manufacturers of high performance solar PV modules which are used to power residential, commercial and other large scale utilities. With our highly reliable solar PV modules, produced in a state of the art manufacturing facility, we have installed & commissioned more than 60 MW grid connected power plants in India at the end of fiscal year 2013-14.

To Visit Our Website  
**SCAN**  
with a QR code reader



## PMM0230 MODULE



## CELL LAYER DAIGRAM

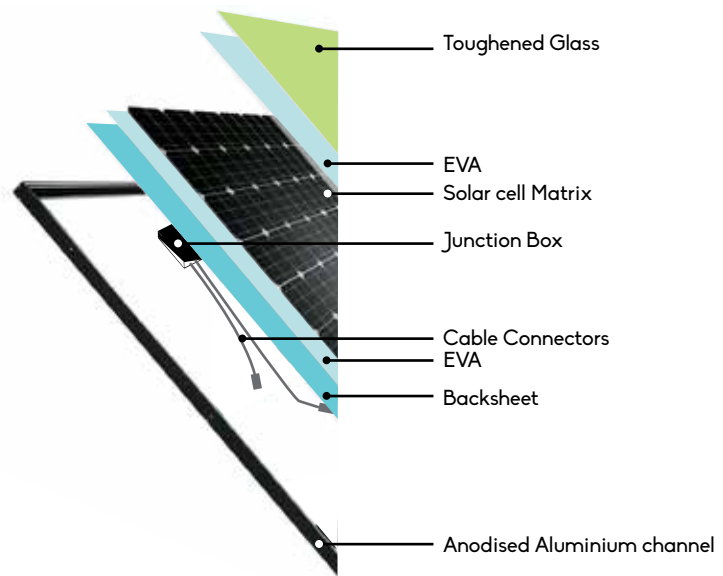

for more details, refer Backpage.

## CERTIFICATIONS & APPROVALS



## AVAILABLE AS PER REQUEST



RFID Tag embedded Modules

## SPECIAL FEATURES

- High energy conversion efficiency because of high fill factor
- Cells sorted by power and current to minimize field mismatch losses.
- Electroluminescence test carried out for micro-cracks



Superior  
25 years Warranty



ISO 9001, ISO 14001  
Certifications



Made in India  
Quality checked



Mechanical Load  
(Wind, Snow) = 5400 Pa



15.2% Module  
Efficiency



Easy Installation  
& Maintenance



Industrial



Commercial



Residential



Rural MicroGrids

10 year product warranty  
25 year power output warranty

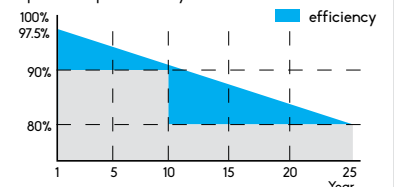

## TECHNICAL DRAWING

### BACK VIEW

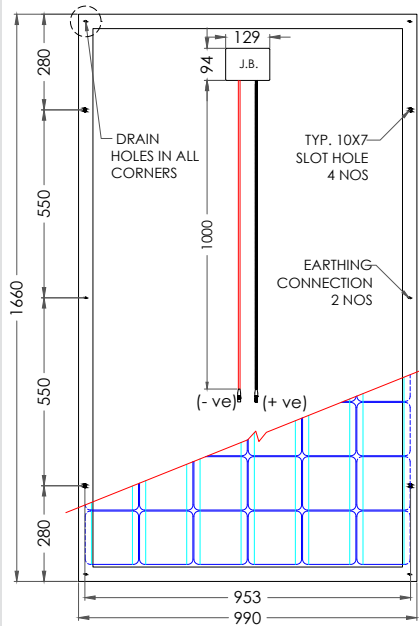

## Series: PMM0225-0240-60

### CURRENT VOLTAGE CURVE

PMM0250

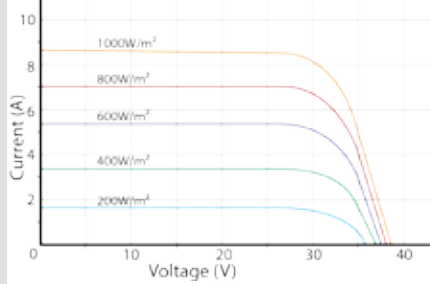

### OPERATING CONDITIONS

Maximum system Voltage - V	1000 VDC
Operating Temperature	- 40 to + 85 °C
Maximum Static Load (Wind/Hail or Snow)	5400 Pa (113 psf)
Maximum series fuse rating (A)	15



PHOTON ENERGY SYSTEMS LIMITED

\* Measured at Standard Test Conditions (STC):  
Irradiance of 1000W/m<sup>2</sup>, AM 1.5, and  
Cell temperature 25° C  
\*\* All Dimensions are in mm.

### PACKAGING DETAILS

Box dimensions L x W x H (mm)	1720 x 1140 x 1170
Gross Box weight (kg)	528
No. of Modules per pallet	24
Number of pallets per 40ft container	24

PMM0225

PMM0230

PMM0235

PMM0240

## ELECTRICAL PARAMETERS AT STANDARD TEST CONDITIONS (STC)

	225	230	235	240
Nominal Power - P <sub>max</sub> (Watts)	225	230	235	240
Power tolerance (%)	± 2	± 2	± 2	± 2
Module Efficiency / Fill Factor (%)	13.6	13.9	14.3	14.6
Voltage at Maximum Power - V <sub>mp</sub> (V)	29.41	29.49	29.56	29.65
Current at Maximum Power - I <sub>mp</sub> (A)	7.65	7.80	7.95	8.10
Open Circuit Voltage - V <sub>oc</sub> (V)	36.41	37.00	37.08	36.39
Short Circuit Current - I <sub>sc</sub> (A)	8.35	8.40	8.45	8.51

### MODULE DATA

L X W X D (mm)	1660 X 990 X 42
Weight (Kg)	20
Area - Sq.m	1.64
Frame Material	Silver White color Anodised Aluminium channel
Glass	3.2 mm Tempered Low Iron Textured toughened glass
Junction Box	Solar Box-RH3, with IP 67 and 3 Bypass diodes ( Make: Huber+ Shuner)
Cable connector	Radox Solar Connectors with 1m length cable (make: Huber +Suhner)
Cell encapsulation material	Ethylene Vinyl Acetate
Backside Sheet	Multi layered PET based film

### CELL DATA

Cell type	Mono-Crystalline
Solar Cells per Module	60
Parent Solar Cell Size	156 x 156

### TEMPERATURE COEFFICIENT

P <sub>max</sub>	- 0.430 % / °C
V <sub>oc</sub>	- 0.330 % / °C
I <sub>sc</sub>	+ 0.058 % / °C

**References:** Specifications included in this datasheet are subject to change without notice.  
However proper care has been taken to ensure the accuracy of provided data.

**Caution:** Read safety and installation instructions before using this product. This module should not be directly connected to a load.

Photon Energy Systems Limited  
775-K, Road No. 45, Jubilee Hills,  
Hyderabad – 500 033, A.P., INDIA  
Tel: +91 40 2333 1337 / 38 / 39 Fax: +91 40 2333 1340  
E-mail us: [factory@photonsolar.in](mailto:factory@photonsolar.in) Website: [www.photonsolar.in](http://www.photonsolar.in)



for sales inquiry, email us at [spvmarketing@photonsolar.in](mailto:spvmarketing@photonsolar.in)

for our Dealers Network, kindly visit:  
<http://photonsolar.in/html/dealers-network.html>

# PHOTON ENERGY SYSTEMS LIMITED

Mono - Crystalline

Series: PM0240-0250-60

☎ 1800 4252 786

 [www.fb.com/PhotonSolarPower](http://www.fb.com/PhotonSolarPower)



## ABOUT

Established in 1995, Photon Energy Systems Limited is one of the most experienced solar energy companies in the World. At Photon, we are the leading manufacturers of high performance solar PV modules which are used to power residential, commercial and other large scale utilities. With our highly reliable solar PV modules, produced in a state of the art manufacturing facility, we have installed & commissioned more than 60 MW grid connected power plants in India at the end of fiscal year 2013-14.

To Visit Our Website

## SCAN

with a QR code reader



## PMM0250 MODULE



## CELL LAYER DAIGRAM

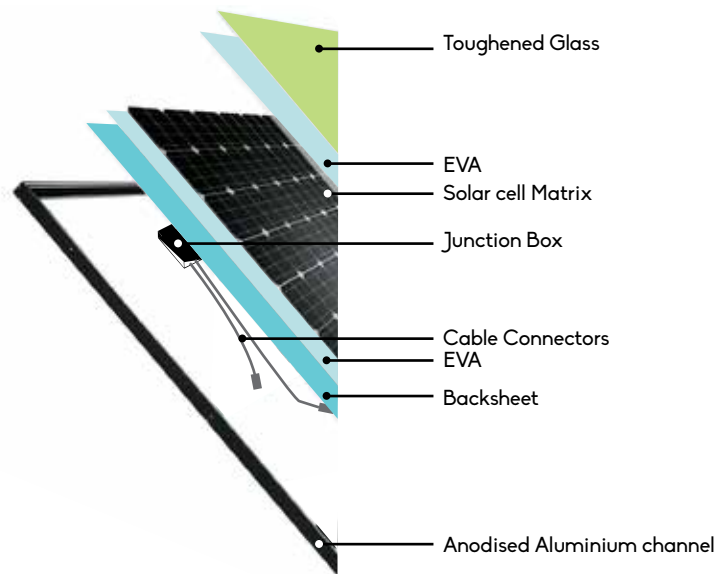

for more details, refer Backpage.

## CERTIFICATIONS & APPROVALS



## AVAILABLE AS PER REQUEST



RFID Tag embedded Modules

## SPECIAL FEATURES

- High energy conversion efficiency because of high fill factor
- Cells sorted by power and current to minimize field mismatch losses.
- Electroluminescence test carried out for micro-cracks



Superior  
25 years Warranty



Certifications: ISO  
9001, ISO 14001



Made in India  
Quality checked



Mechanical Load  
(Wind, Snow) = 5400 Pa



15.2% Module  
Efficiency



Easy Installation  
& Maintainece



Industrial



Commercial



Residential



Rural MicroGrids

10 year product warranty  
25 year power output warranty

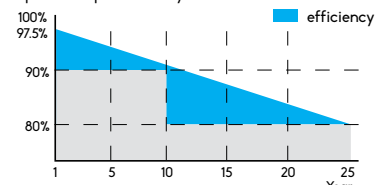

## TECHNICAL DRAWING

### BACK VIEW

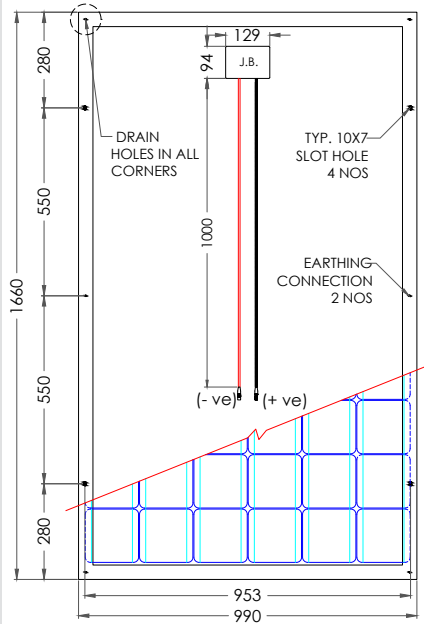

## Series: PMM0240-0250-60

### CURRENT VOLTAGE CURVE

PMM0250

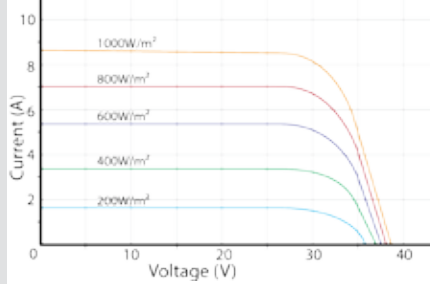

### OPERATING CONDITIONS

Maximum system Voltage - V	1000 VDC
Operating Temperature	- 40 to + 85 °C
Maximum Static Load (Wind/Hail or Snow)	5400 Pa (113 psf)
Maximum series fuse rating (A)	15



PHOTON ENERGY SYSTEMS LIMITED

\* Measured at Standard Test Conditions (STC):  
Irradiance of 1000W/m<sup>2</sup>, AM 1.5, and  
Cell temperature 25° C  
\*\* All Dimensions are in mm.

### PACKAGING DETAILS

Box dimensions L x W x H (mm)	1720 x 1140 x 1170
Gross Box weight (kg)	528
No. of Modules per pallet	24
Number of pallets per 40ft container	24

PMM0240

PMM0250

## ELECTRICAL PARAMETERS AT STANDARD TEST CONDITIONS (STC)

Nominal Power - P <sub>max</sub> (Watts)	<b>240</b>	<b>250</b>
Power tolerance (%)	± 2	± 2
Module Efficiency / Fill Factor (%)	14.6	15.2
Voltage at Maximum Power - V <sub>mp</sub> (V)	29.65	30.49
Current at Maximum Power - I <sub>sc</sub> (A)	8.10	8.20
Open Circuit Voltage - V <sub>oc</sub> (V)	36.39	37.27
Short Circuit Current - I <sub>sc</sub> (A)	8.51	8.60

### MODULE DATA

L X W X D (mm)	1660 X 990 X 42
Weight (Kg)	20
Area - Sq.m	1.64
Frame Material	Silver White color Anodised Aluminium channel
Glass	3.2 mm Tempered Low Iron Textured toughened glass
Junction Box	Solar Box-RH3, with IP 67 and 3 Bypass diodes ( Make: Huber+ Shuner)
Cable connector	Radox Solar Connectors with 1m length cable (Make: Huber +Suhner)
Cell encapsulation material	Ethylene Vinyl Acetate
Backside Sheet	Multi layered PET based film

### CELL DATA

Cell type	Mono-Crystalline
Solar Cells per Module	<b>60</b>
Parent Solar Cell Size	156 x 156

### TEMPERATURE COEFFICIENT

P <sub>max</sub>	- 0.430 % / °C
V <sub>oc</sub>	- 0.330 % / °C
I <sub>sc</sub>	+ 0.058 % / °C

**References:** Specifications included in this datasheet are subject to change without notice.  
However proper care has been taken to ensure the accuracy of provided data.

**Caution:** Read safety and installation instructions before using this product. This module should not be directly connected to a load.

Photon Energy Systems Limited  
775-K, Road No. 45, Jubilee Hills,  
Hyderabad – 500 033, A.P., INDIA  
Tel: +91 40 2333 1337 / 38 / 39 Fax: +91 40 2333 1340  
E-mail us: [factory@photonsolar.in](mailto:factory@photonsolar.in) Website: [www.photonsolar.in](http://www.photonsolar.in)



for sales inquiry, email us at [spvmarketing@photonsolar.in](mailto:spvmarketing@photonsolar.in)

for our Dealers Network, kindly visit:  
<http://photonsolar.in/html/dealers-network.html>

# PHOTON ENERGY SYSTEMS LIMITED

Multi - Crystalline

Series: PM0295-0305-72

☎ 1800 4252 786

 [www.fb.com/PhotonSolarPower](http://www.fb.com/PhotonSolarPower)



## ABOUT

Established in 1995, Photon Energy Systems Limited is one of the most experienced solar energy companies in the World. At Photon, we are the leading manufacturers of high performance solar PV modules which are used to power residential, commercial and other large scale utilities. With our highly reliable solar PV modules, produced in a state of the art manufacturing facility, we have installed & commissioned more than 60 MW grid connected power plants in India at the end of fiscal year 2013-14.

To Visit Our Website

## SCAN

with a QR code reader



## PM0300 MODULE



## CELL LAYER DAIGRAM

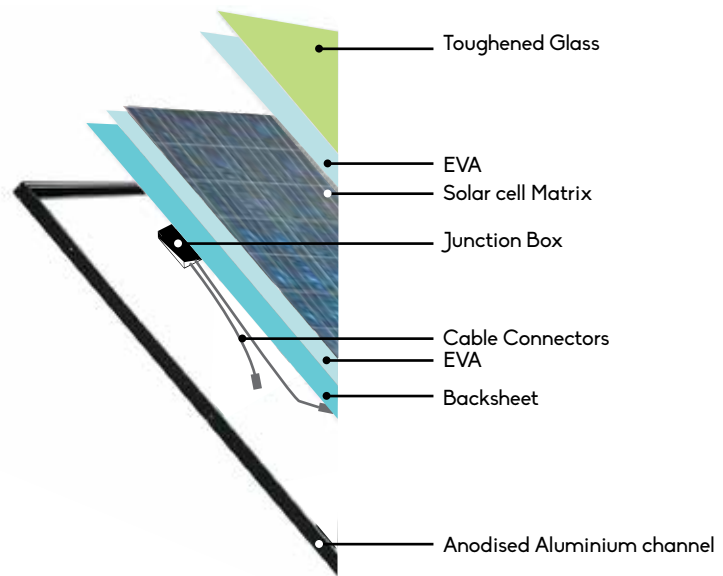

for more details, refer Backpage.

## CERTIFICATIONS & APPROVALS



## AVAILABLE AS PER REQUEST



PID free cells  
(Potential Induced Degradation)



RFID Tag  
embedded Modules

## SPECIAL FEATURES

- High energy conversion efficiency because of high fill factor
- Cells sorted by power and current to minimize field mismatch losses.
- Electroluminescence test carried out for micro-cracks



Superior  
25 years Warranty



Certifications: ISO  
9001, ISO 14001



Made in India  
Quality checked



Mechanical Load  
(Wind, Snow) = 5400 Pa



15.2% Module  
Efficiency



Easy Installation  
& Maintenance



Industrial



Commercial



Residential



Rural MicroGrids

10 year product warranty  
25 year power output warranty

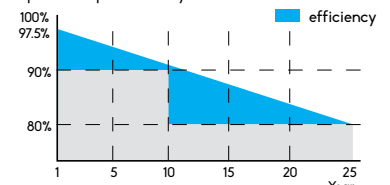

## TECHNICAL DRAWING

### BACK VIEW

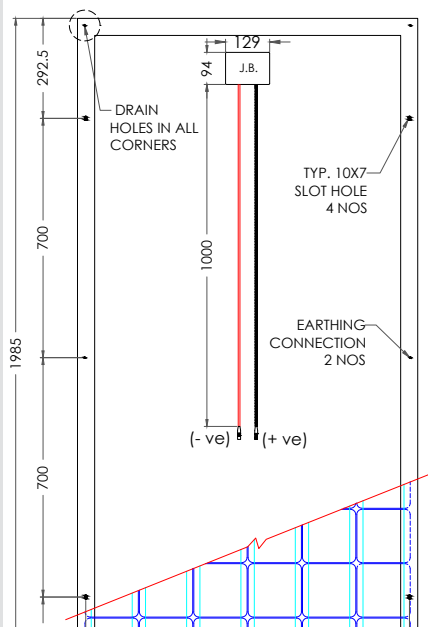

## Series: PM0295-0305-72

### CURRENT VOLTAGE CURVE PM0300

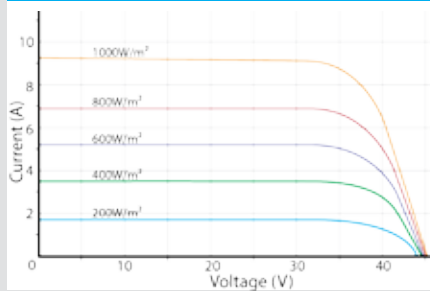

### OPERATING CONDITIONS

Maximum system Voltage - V	1000 VDC
Operating Temperature	- 40 to + 85 °C
Maximum Static Load (Wind/Hail or Snow)	5400 Pa (113 psf)
Maximum series fuse rating (A)	15



PHOTON ENERGY SYSTEMS LIMITED

\* Measured at Standard Test Conditions (STC):  
Irradiance of 1000W/m<sup>2</sup>, AM 1.5, and  
Cell temperature 25° C  
\*\* All Dimensions are in mm.

### PACKAGING DETAILS

No. of Modules per pallet	24
Number of pallets per 40ft container	24

PM0295

PM0300

PM0305

### ELECTRICAL PARAMETERS AT STANDARD TEST CONDITIONS (STC)

	295	300	305
Nominal Power - P <sub>max</sub> (Watts)	295	300	305
Power tolerance (%)	± 2	± 2	± 2
Module Efficiency / Fill Factor (%)	15.2	15.4	15.6
Voltage at Maximum Power - V <sub>mp</sub> (V)	37.08	37.25	37.42
Current at Maximum Power - I <sub>sc</sub> (A)	7.97	8.07	8.16
Open Circuit Voltage - V <sub>oc</sub> (V)	44.24	44.46	44.68
Short Circuit Current - I <sub>sc</sub> (A)	8.52	8.58	8.64

### ELECTRICAL PARAMETERS AT NOCT

	214.17	217.8	221.43
P <sub>max</sub> (Watts)	214.17	217.8	221.43
Voltage at Max. Power - V <sub>mp</sub> (V)	33.57	33.77	33.91
Current at Max. Power - I <sub>mp</sub> (A)	6.38	6.45	6.53
Open Circuit Voltage - V <sub>oc</sub> (V)	42.14	42.31	42.47
Short Circuit Current - I <sub>sc</sub> (A)	6.84	6.89	6.93

### MODULE DATA

L X W X D (mm)	1990 X 997 X 50
Weight (Kg)	28
Area - Sq.m	1.98
Frame Material	Silver White color Anodised Aluminium channel
Glass	3.2 mm Tempered Low Iron Textured toughened glass
Junction Box	Solar Box-RH3, with IP 67 and 3 Bypass diodes ( Make: Huber+ Shuner)
Cable connector	Radox Solar Connectors with 1m length cable (make: Huber +Suhner)
Cell encapsulation material	Ethylene Vinyl Acetate
Backside Sheet	Multi layered PET based film

### CELL DATA

Cell type	Multi-Crystalline
Solar Cells per Module	72
Parent Solar Cell Size	156 x 156

### TEMPERATURE COEFFICIENT

P <sub>max</sub>	- 0.430 % / °C
V <sub>oc</sub>	- 0.330 % / °C
I <sub>sc</sub>	+ 0.058 % / °C

**References:** Specifications included in this datasheet are subject to change without notice.  
However proper care has been taken to ensure the accuracy of provided data.

**Caution:** Read safety and installation instructions before using this product. This module should not be directly connected to a load.

Photon Energy Systems Limited  
775-K, Road No. 45, Jubilee Hills,  
Hyderabad - 500 033, A.P., INDIA  
Tel: +91 40 2333 1337 / 38 / 39 Fax: +91 40 2333 1340  
E-mail us: [factory@photonsolar.in](mailto:factory@photonsolar.in) Website: [www.photonsolar.in](http://www.photonsolar.in)



for sales inquiry, email us at [spvmarketing@photonsolar.in](mailto:spvmarketing@photonsolar.in)

for our Dealers Network, kindly visit:  
<http://photonsolar.in/html/dealers-network.html>

# PHOTON ENERGY SYSTEMS LIMITED

Multi - Crystalline

Series: PM0280-0290-72

☎ 1800 4252 786

 [www.fb.com/PhotonSolarPower](http://www.fb.com/PhotonSolarPower)



## ABOUT

Established in 1995, Photon Energy Systems Limited is one of the most experienced solar energy companies in the World. At Photon, we are the leading manufacturers of high performance solar PV modules which are used to power residential, commercial and other large scale utilities. With our highly reliable solar PV modules, produced in a state of the art manufacturing facility, we have installed & commissioned more than 60 MW grid connected power plants in India at the end of fiscal year 2013-14.

To Visit Our Website

## SCAN

with a QR code reader



## PM0300 MODULE



## CELL LAYER DAIGRAM

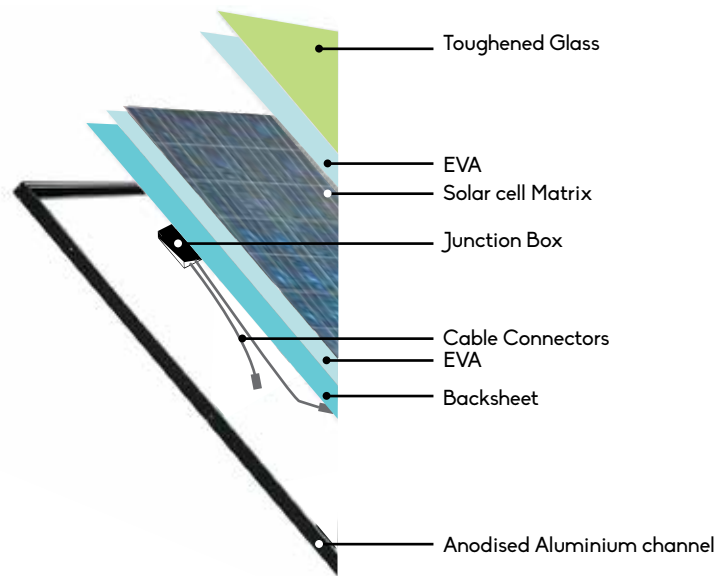

for more details, refer Backpage.

## CERTIFICATIONS & APPROVALS



## AVAILABLE AS PER REQUEST



PID free cells  
(Potential Induced Degradation)



RFID Tag  
embedded Modules

## SPECIAL FEATURES

- High energy conversion efficiency because of high fill factor
- Cells sorted by power and current to minimize field mismatch losses.
- Electroluminescence test carried out for micro-cracks



Superior  
25 years Warranty



Certifications: ISO  
9001, ISO 14001



Made in India  
Quality checked



Mechanical Load  
(Wind, Snow) = 5400 Pa



15.2% Module  
Efficiency



Easy Installation  
& Maintenance



Industrial



Commercial



Residential



Rural MicroGrids

10 year product warranty  
25 year power output warranty

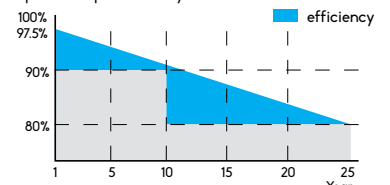



## TECHNICAL DRAWING

### BACK VIEW

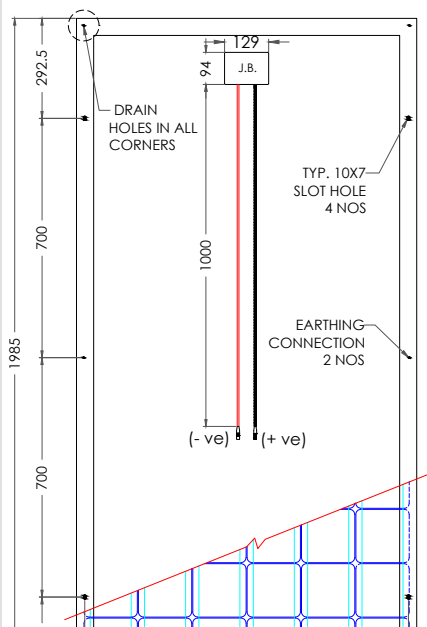

## Series: PM0280-0290-72

### CURRENT VOLTAGE CURVE PM0300

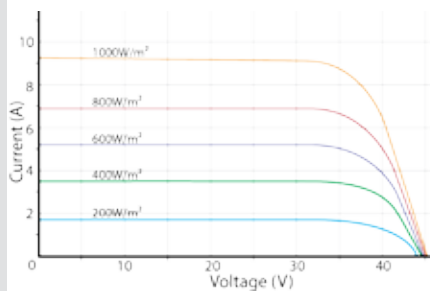

### OPERATING CONDITIONS

Maximum system Voltage - V	1000 VDC
Operating Temperature	- 40 to + 85 °C
Maximum Static Load (Wind/Hail or Snow)	5400 Pa (113 psf)
Maximum series fuse rating (A)	15



PHOTON ENERGY SYSTEMS LIMITED

\* Measured at Standard Test Conditions (STC): Irradiance of 1000W/m<sup>2</sup>, AM 1.5, and Cell temperature 25° C  
 \*\* All Dimensions are in mm.

### PACKAGING DETAILS

No. of Modules per pallet	24
Number of pallets per 40ft container	24

PM0280

PM0285

PM0290

### ELECTRICAL PARAMETERS AT STANDARD TEST CONDITIONS (STC)

	280	285	290
Nominal Power - P <sub>max</sub> (Watts)	280	285	290
Power tolerance (%)	± 2	± 2	± 2
Module Efficiency / Fill Factor (%)	14.4	14.7	14.9
Voltage at Maximum Power - V <sub>mp</sub> (V)	36.50	36.72	36.94
Current at Maximum Power - I <sub>sc</sub> (A)	7.68	7.78	7.87
Open Circuit Voltage - V <sub>oc</sub> (V)	43.60	43.81	44.03
Short Circuit Current - I <sub>sc</sub> (A)	8.34	8.40	8.46

### ELECTRICAL PARAMETERS AT NOCT

P <sub>max</sub> (Watts)	203.28	206.9	210.54
Voltage at Max. Power - V <sub>mp</sub> (V)	33.58	33.78	33.98
Current at Max. Power - I <sub>mp</sub> (A)	6.05	6.12	6.19
Open Circuit Voltage - V <sub>oc</sub> (V)	40.8	41.06	41.21
Short Circuit Current - I <sub>sc</sub> (A)	6.5	6.55	6.6

### MODULE DATA

L X W X D (mm)	1990 X 997 X 50
Weight (Kg)	28
Area - Sq.m	1.98
Frame Material	Silver White color Anodised Aluminium channel
Glass	3.2 mm Tempered Low Iron Textured toughened glass
Junction Box	Solar Box-RH3, with IP 67 and 3 Bypass diodes ( Make: Huber+ Shuner)
Cable connector	Radox Solar Connectors with 1m length cable (make: Huber +Suhner)
Cell encapsulation material	Ethylene Vinyl Acetate
Backside Sheet	Multi layered PET based film

### CELL DATA

Cell type	Multi-Crystalline
Solar Cells per Module	72
Parent Solar Cell Size	156 x 156

### TEMPERATURE COEFFICIENT

P <sub>max</sub>	- 0.430 % / °C
V <sub>oc</sub>	- 0.330 % / °C
I <sub>sc</sub>	+ 0.058 % / °C

**References:** Specifications included in this datasheet are subject to change without notice. However proper care has been taken to ensure the accuracy of provided data.

**Caution:** Read safety and installation instructions before using this product. This module should not be directly connected to a load.

Photon Energy Systems Limited  
 775-K, Road No. 45, Jubilee Hills,  
 Hyderabad - 500 033, A.P., INDIA  
 Tel: +91 40 2333 1337 / 38 / 39 Fax: +91 40 2333 1340  
 E-mail us: [factory@photonsolar.in](mailto:factory@photonsolar.in) Website: [www.photonsolar.in](http://www.photonsolar.in)



for sales inquiry, email us at [spvmarketing@photonsolar.in](mailto:spvmarketing@photonsolar.in)

for our Dealers Network, kindly visit:  
<http://photonsolar.in/html/dealers-network.html>

# PHOTON ENERGY SYSTEMS LIMITED

Multi - Crystalline

Series: PM0250-0275-72

☎ 1800 4252 786

 [www.fb.com/PhotonSolarPower](http://www.fb.com/PhotonSolarPower)



## ABOUT

Established in 1995, Photon Energy Systems Limited is one of the most experienced solar energy companies in the World. At Photon, we are the leading manufacturers of high performance solar PV modules which are used to power residential, commercial and other large scale utilities. With our highly reliable solar PV modules, produced in a state of the art manufacturing facility, we have installed & commissioned more than 60 MW grid connected power plants in India at the end of fiscal year 2013-14.

To Visit Our Website

## SCAN

with a QR code reader



## PM0300 MODULE



## CELL LAYER DAIGRAM

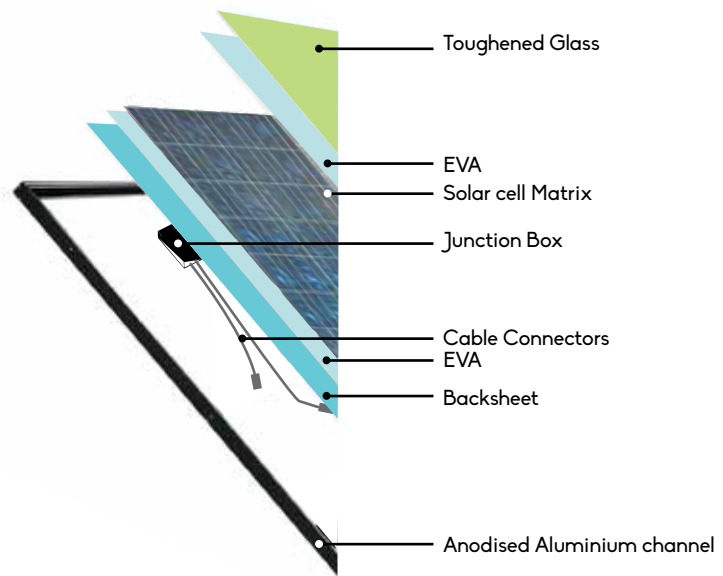

for more details, refer Backpage.

## CERTIFICATIONS & APPROVALS



## AVAILABLE AS PER REQUEST



PID free cells  
(Potential Induced Degradation)



RFID Tag  
embedded Modules

## SPECIAL FEATURES

- High energy conversion efficiency because of high fill factor
- Cells sorted by power and current to minimize field mismatch losses.
- Electroluminescence test carried out for micro-cracks



Superior  
25 years Warranty



Certifications: ISO  
9001, ISO 14001



Made in India  
Quality checked



Mechanical Load  
(Wind, Snow) = 5400 Pa



15.2% Module  
Efficiency



Easy Installation  
& Maintenance



Industrial



Commercial



Residential



Rural MicroGrids

10 year product warranty  
25 year power output warranty

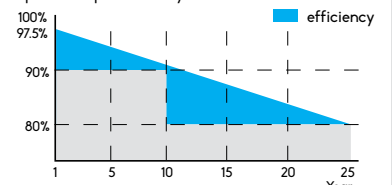

## TECHNICAL DRAWING

### BACK VIEW

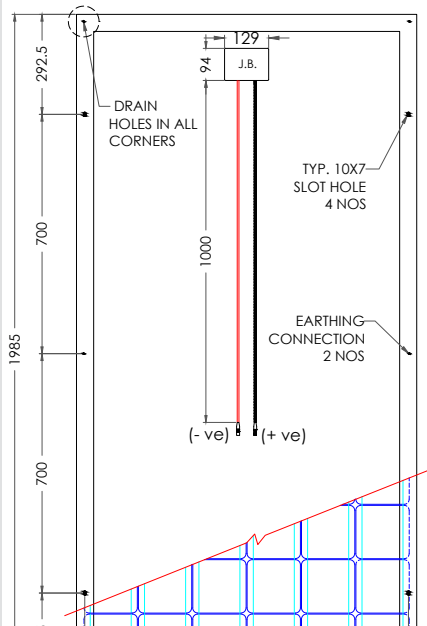

## Series: PM0250-0275-72

### CURRENT VOLTAGE CURVE PM0300

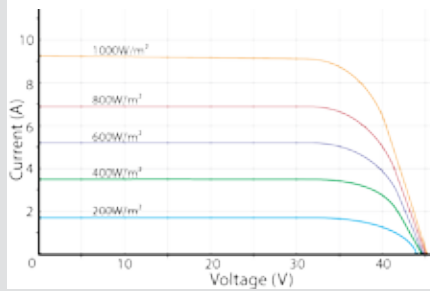

### OPERATING CONDITIONS

Maximum system Voltage - V	1000 VDC
Operating Temperature	- 40 to + 85 °C
Maximum Static Load (Wind/Hail or Snow)	5400 Pa (113 psf)
Maximum series fuse rating (A)	15



PHOTON ENERGY SYSTEMS LIMITED

\* Measured at Standard Test Conditions (STC):  
Irradiance of 1000W/m<sup>2</sup>, AM 1.5, and  
Cell temperature 25° C  
\*\* All Dimensions are in mm.

### PACKAGING DETAILS

No. of Modules per pallet	24
Number of pallets per 40ft container	24

PM0250

PM0270

PM0275

### ELECTRICAL PARAMETERS AT STANDARD TEST CONDITIONS (STC)

	250	270	275
Nominal Power - P <sub>max</sub> (Watts)	250	270	275
Power tolerance (%)	± 2	± 2	± 2
Module Efficiency / Fill Factor (%)	12.9	13.9	14.1
Voltage at Maximum Power - V <sub>mp</sub> (V)	36.07	36.07	36.29
Current at Maximum Power - I <sub>sc</sub> (A)	6.93	7.49	7.59
Open Circuit Voltage - V <sub>oc</sub> (V)	43.06	43.06	43.34
Short Circuit Current - I <sub>sc</sub> (A)	7.74	8.22	8.28

### ELECTRICAL PARAMETERS AT NOCT

P <sub>max</sub> (Watts)	181.5	196.02	199.65
Voltage at Max. Power - V <sub>mp</sub> (V)	33.18	33.18	33.38
Current at Max. Power - I <sub>mp</sub> (A)	5.47	5.906	5.98
Open Circuit Voltage - V <sub>oc</sub> (V)	40.3	40.3	40.57
Short Circuit Current - I <sub>sc</sub> (A)	6.03	6.41	6.45

### MODULE DATA

L X W X D (mm)	1990 X 997 X 50
Weight (Kg)	28
Area - Sq.m	1.98
Frame Material	Silver White color Anodised Aluminium channel
Glass	3.2 mm Tempered Low Iron Textured toughened glass
Junction Box	Solar Box-RH3, with IP 67 and 3 Bypass diodes ( Make: Huber+ Shuner)
Cable connector	Radox Solar Connectors with 1m length cable (make: Huber +Suhner)
Cell encapsulation material	Ethylene Vinyl Acetate
Backside Sheet	Multi layered PET based film

### CELL DATA

Cell type	Multi-Crystalline
Solar Cells per Module	72
Parent Solar Cell Size	156 x 156

### TEMPERATURE COEFFICIENT

P <sub>max</sub>	- 0.430 % / °C
V <sub>oc</sub>	- 0.330 % / °C
I <sub>sc</sub>	+ 0.058 % / °C

**References:** Specifications included in this datasheet are subject to change without notice. However proper care has been taken to ensure the accuracy of provided data.

**Caution:** Read safety and installation instructions before using this product. This module should not be directly connected to a load.

Photon Energy Systems Limited  
775-K, Road No. 45, Jubilee Hills,  
Hyderabad – 500 033, A.P., INDIA  
Tel: +91 40 2333 1337 / 38 / 39 Fax: +91 40 2333 1340  
E-mail us: [factory@photonsolar.in](mailto:factory@photonsolar.in) Website: [www.photonsolar.in](http://www.photonsolar.in)



for sales inquiry, email us at [spvmarketing@photonsolar.in](mailto:spvmarketing@photonsolar.in)

for our Dealers Network, kindly visit:  
<http://photonsolar.in/html/dealers-network.html>

# PHOTON ENERGY SYSTEMS LIMITED

Multi - Crystalline

Series: PM0245-0260-60

☎ 1800 4252 786

 [www.fb.com/PhotonSolarPower](http://www.fb.com/PhotonSolarPower)



## ABOUT

Established in 1995, Photon Energy Systems Limited is one of the most experienced solar energy companies in the World. At Photon, we are the leading manufacturers of high performance solar PV modules which are used to power residential, commercial and other large scale utilities. With our highly reliable solar PV modules, produced in a state of the art manufacturing facility, we have installed & commissioned more than 60 MW grid connected power plants in India at the end of fiscal year 2013-14.

To Visit Our Website

## SCAN

with a QR code reader



## PM0250 MODULE

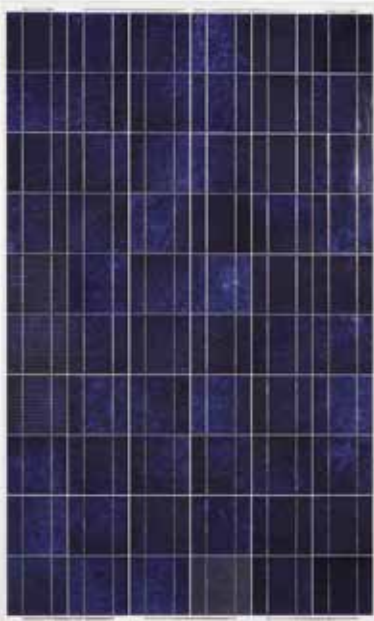

## CELL LAYER DAIGRAM

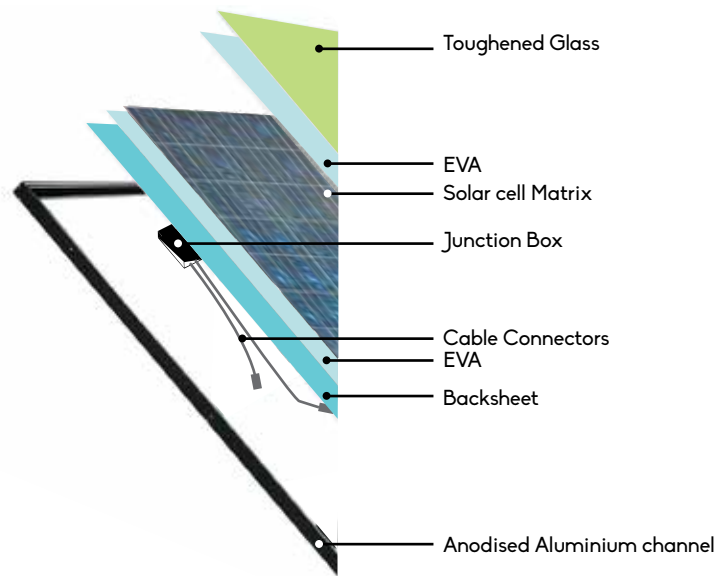

for more details, refer Backpage.

## CERTIFICATIONS & APPROVALS



## AVAILABLE AS PER REQUEST



PID free cells  
(Potential Induced Degradation)



RFID Tag  
embedded Modules

## SPECIAL FEATURES

- High energy conversion efficiency because of high fill factor
- Cells sorted by power and current to minimize field mismatch losses.
- Electroluminescence test carried out for micro-cracks



Superior  
25 years Warranty



Certifications: ISO  
9001, ISO 14001



Made in India  
Quality checked



Mechanical Load  
(Wind, Snow) = 5400 Pa



15.2% Module  
Efficiency



Easy Installation  
& Maintainece



Industrial



Commercial



Residential



Rural MicroGrids

10 year product warranty  
25 year power output warranty

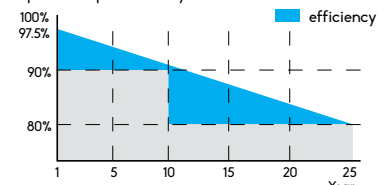

## TECHNICAL DRAWING

### BACK VIEW

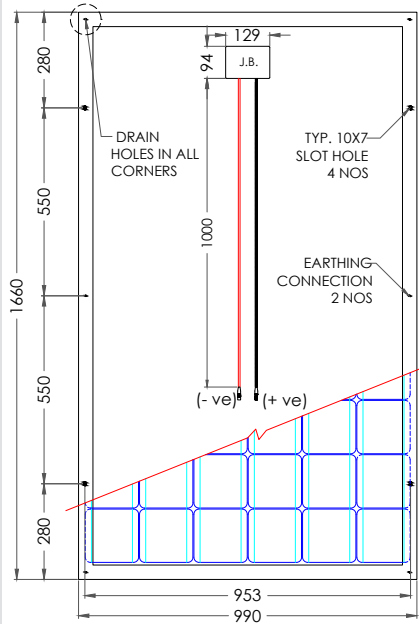

## Series: PM0245-0260-60

### CURRENT VOLTAGE CURVE PM0250

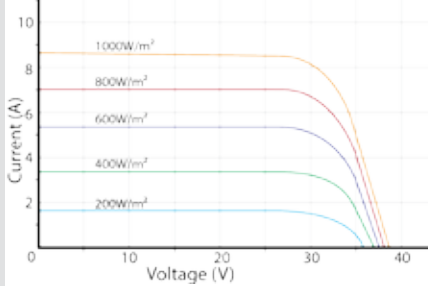

### OPERATING CONDITIONS

Maximum system Voltage - V	1000 VDC
Operating Temperature	- 40 to + 85 °C
Maximum Static Load (Wind/Hail or Snow)	5400 Pa (113 psf)
Maximum series fuse rating (A)	15



PHOTON ENERGY SYSTEMS LIMITED

\* Measured at Standard Test Conditions (STC): Irradiance of 1000W/m<sup>2</sup>, AM 1.5, and Cell temperature 25° C  
 \*\* All Dimensions are in mm.

### PACKAGING DETAILS

Box dimensions L x W x H (mm)	1720 x 1140 x 1170
Gross Box weight (kg)	528
No. of Modules per pallet	24
Number of pallets per 40ft container	24

PM0245

PM0250

PM0255

PM0260

### ELECTRICAL PARAMETERS AT STANDARD TEST CONDITIONS (STC)

	245	250	255	260
Nominal Power - P <sub>max</sub> (Watts)	245	250	255	260
Power tolerance (%)	± 2	± 2	± 2	± 2
Module Efficiency / Fill Factor (%)	14.8	15.2	15.5	15.8
Voltage at Maximum Power - V <sub>mp</sub> (V)	30.58	30.72	30.90	31.32
Current at Maximum Power - I <sub>sc</sub> (A)	8.01	8.15	8.42	8.54
Open Circuit Voltage - V <sub>oc</sub> (V)	36.87	37.05	37.44	37.80
Short Circuit Current - I <sub>sc</sub> (A)	8.52	8.58	8.98	9.09

### ELECTRICAL PARAMETERS AT NOCT

P <sub>max</sub> (Watts)	177.87	181.5	185.13	188.76
Voltage at Max. Power - V <sub>mp</sub> (V)	27.2	27.71	27.71	28.05
Current at Max. Power - I <sub>mp</sub> (A)	6.54	6.62	6.68	6.73
Open Circuit Voltage - V <sub>oc</sub> (V)	34.48	34.61	34.68	34.76
Short Circuit Current - I <sub>sc</sub> (A)	7.03	7.13	7.18	7.21

### MODULE DATA

L X W X D (mm)	1660 x 990 x 45
Weight (Kg)	20
Area - Sq.m	1.64
Frame Material	Silver White color Anodised Aluminium channel
Glass	3.2 mm Tempered Low Iron Textured toughened glass
Junction Box	Solar Box-RH3, with IP 67 and 3 Bypass diodes ( Make: Huber+ Shuner)
Cable connector	Radox Solar Connectors with 1m length cable (make: Huber +Suhner)
Cell encapsulation material	Ethylene Vinyl Acetate
Backside Sheet	Multi layered PET based film

### CELL DATA

Cell type	Multi-Crystalline
Solar Cells per Module	60
Parent Solar Cell Size	156 x 156

### TEMPERATURE COEFFICIENT

P <sub>max</sub>	- 0.430 % / °C
V <sub>oc</sub>	- 0.330 % / °C
I <sub>sc</sub>	+ 0.058 % / °C

**References:** Specifications included in this datasheet are subject to change without notice. However proper care has been taken to ensure the accuracy of provided data.

**Caution:** Read safety and installation instructions before using this product. This module should not be directly connected to a load.

Photon Energy Systems Limited  
 775-K, Road No. 45, Jubilee Hills,  
 Hyderabad - 500 033, A.P., INDIA  
 Tel: +91 40 2333 1337 / 38 / 39 Fax: +91 40 2333 1340  
 E-mail us: [factory@photonsolar.in](mailto:factory@photonsolar.in) Website: [www.photonsolar.in](http://www.photonsolar.in)



for sales inquiry, email us at [spvmarketing@photonsolar.in](mailto:spvmarketing@photonsolar.in)

for our Dealers Network, kindly visit:  
<http://photonsolar.in/html/dealers-network.html>

# PHOTON ENERGY SYSTEMS LIMITED

Multi - Crystalline

Series: PM0225-0240-60

☎ 1800 4252 786

 [www.fb.com/PhotonSolarPower](http://www.fb.com/PhotonSolarPower)



## ABOUT

Established in 1995, Photon Energy Systems Limited is one of the most experienced solar energy companies in the World. At Photon, we are the leading manufacturers of high performance solar PV modules which are used to power residential, commercial and other large scale utilities. With our highly reliable solar PV modules, produced in a state of the art manufacturing facility, we have installed & commissioned more than 60 MW grid connected power plants in India at the end of fiscal year 2013-14.

To Visit Our Website

## SCAN

with a QR code reader



## PM0250 MODULE



## CELL LAYER DAIGRAM

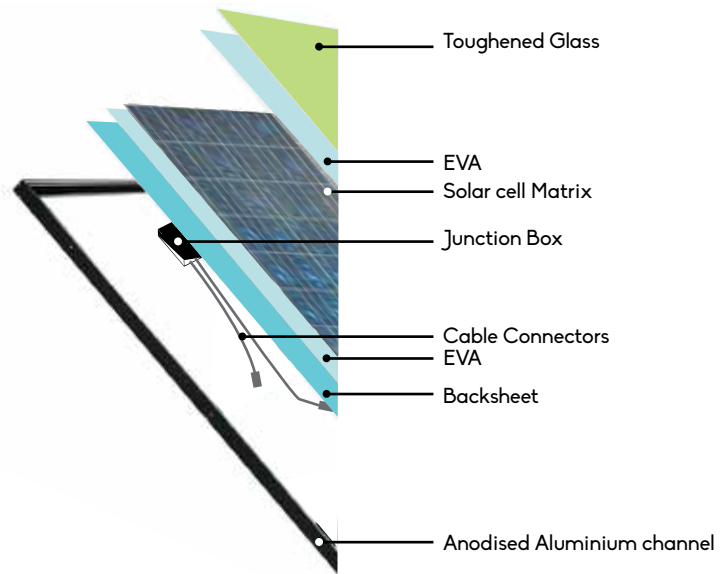

for more details, refer Backpage.

## CERTIFICATIONS & APPROVALS



## AVAILABLE AS PER REQUEST



PID free cells  
(Potential Induced Degradation)



RFID Tag  
embedded Modules

## SPECIAL FEATURES

- High energy conversion efficiency because of high fill factor
- Cells sorted by power and current to minimize field mismatch losses.
- Electroluminescence test carried out for micro-cracks



Superior  
25 years Warranty



Certifications: ISO  
9001, ISO 14001



Made in India  
Quality checked



Mechanical Load  
(Wind, Snow) = 5400 Pa



15.2% Module  
Efficiency



Easy Installation  
& Maintainece



Industrial



Commercial



Residential



Rural MicroGrids

10 year product warranty  
25 year power output warranty

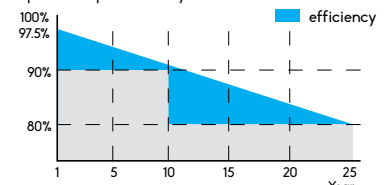

## TECHNICAL DRAWING

### BACK VIEW

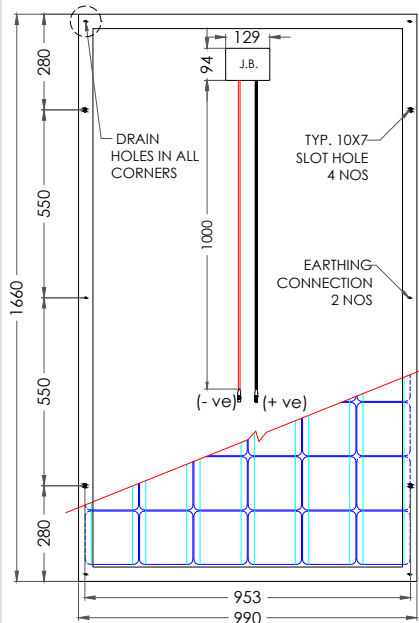

## Series: PM0225-0240-60

### CURRENT VOLTAGE CURVE PM0250

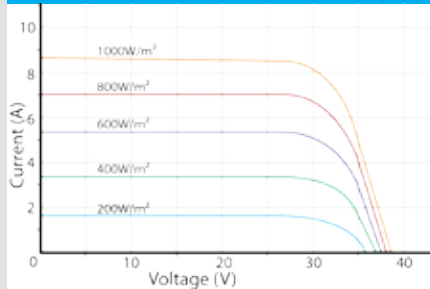

### OPERATING CONDITIONS

Maximum system Voltage - V	1000 VDC
Operating Temperature	- 40 to + 85 °C
Maximum Static Load (Wind/Hail or Snow)	5400 Pa (113 psf)
Maximum series fuse rating (A)	15



PHOTON ENERGY SYSTEMS LIMITED

\* Measured at Standard Test Conditions (STC):  
Irradiance of 1000W/m<sup>2</sup>, AM 1.5, and  
Cell temperature 25° C  
\*\* All Dimensions are in mm.

### PACKAGING DETAILS

Box dimensions L x W x H (mm)	1720 x 1140 x 1170
Gross Box weight (kg)	528
No. of Modules per pallet	24
Number of pallets per 40ft container	24

PM0225

PM0230

PM0235

PM0240

## ELECTRICAL PARAMETERS AT STANDARD TEST CONDITIONS (STC)

	225	230	235	240
Nominal Power - P <sub>max</sub> (Watts)	225	230	235	240
Power tolerance (%)	± 2	± 2	± 2	± 2
Module Efficiency / Fill Factor (%)	13.6	13.9	14.3	14.6
Voltage at Maximum Power - V <sub>mp</sub> (V)	30.06	30.33	30.48	30.52
Current at Maximum Power - I <sub>sc</sub> (A)	7.49	7.63	7.71	7.86
Open Circuit Voltage - V <sub>oc</sub> (V)	35.88	36.24	36.42	36.60
Short Circuit Current - I <sub>sc</sub> (A)	8.22	8.31	8.37	8.43

### MODULE DATA

L X W X D (mm)	1660 x 990 x 45
Weight (Kg)	20
Area - Sq.m	1.64
Frame Material	Silver White color Anodised Aluminium channel
Glass	3.2 mm Tempered Low Iron Textured toughened glass
Junction Box	Solar Box-RH3, with IP 67 and 3 Bypass diodes ( Make: Huber+ Shuner)
Cable connector	Radox Solar Connectors with 1m length cable (make: Huber +Suhner)
Cell encapsulation material	Ethylene Vinyl Acetate
Backside Sheet	Multi layered PET based film

### CELL DATA

Cell type	Multi-Crystalline
Solar Cells per Module	60
Parent Solar Cell Size	156 x 156

### TEMPERATURE COEFFICIENT

P <sub>max</sub>	- 0.430 % / °C
V <sub>oc</sub>	- 0.330 % / °C
I <sub>sc</sub>	+ 0.058 % / °C

**References:** Specifications included in this datasheet are subject to change without notice.  
However proper care has been taken to ensure the accuracy of provided data.

**Caution:** Read safety and installation instructions before using this product. This module should not be directly connected to a load.

Photon Energy Systems Limited  
775-K, Road No. 45, Jubilee Hills,  
Hyderabad – 500 033, A.P., INDIA  
Tel: +91 40 2333 1337 / 38 / 39 Fax: +91 40 2333 1340  
E-mail us: [factory@photonsolar.in](mailto:factory@photonsolar.in) Website: [www.photonsolar.in](http://www.photonsolar.in)



for sales inquiry, email us at [spvmarketing@photonsolar.in](mailto:spvmarketing@photonsolar.in)

for our Dealers Network, kindly visit:  
<http://photonsolar.in/html/dealers-network.html>

# PHOTON ENERGY SYSTEMS LIMITED

Multi - Crystalline

Series: PM0200-0220-54

☎ 1800 4252 786

 [www.fb.com/PhotonSolarPower](http://www.fb.com/PhotonSolarPower)



## ABOUT

Established in 1995, Photon Energy Systems Limited is one of the most experienced solar energy companies in the World. At Photon, we are the leading manufacturers of high performance solar PV modules which are used to power residential, commercial and other large scale utilities. With our highly reliable solar PV modules, produced in a state of the art manufacturing facility, we have installed & commissioned more than 60 MW grid connected power plants in India at the end of fiscal year 2013-14.

To Visit Our Website

## SCAN

with a QR code reader



## PM0200 MODULE



## CELL LAYER DAIGRAM

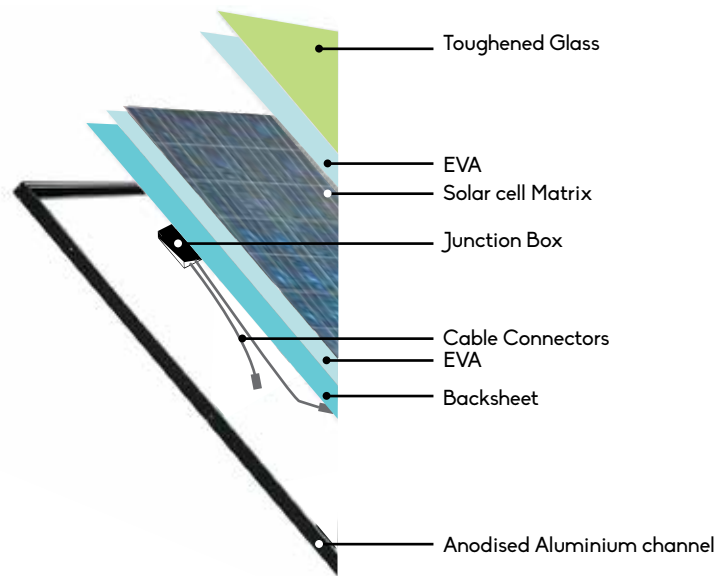

for more details, refer Backpage.

## CERTIFICATIONS & APPROVALS



## AVAILABLE AS PER REQUEST



PID free cells  
(Potential Induced Degradation)



RFID Tag  
embedded Modules

## SPECIAL FEATURES

- High energy conversion efficiency because of high fill factor
- Cells sorted by power and current to minimize field mismatch losses.
- Electroluminescence test carried out for micro-cracks



Superior  
25 years Warranty



Certifications: ISO  
9001, ISO 14001



Made in India  
Quality checked



Mechanical Load  
(Wind, Snow) = 5400 Pa



15.2% Module  
Efficiency



Easy Installation  
& Maintenance



Industrial



Commercial



Residential



Rural MicroGrids

10 year product warranty  
25 year power output warranty

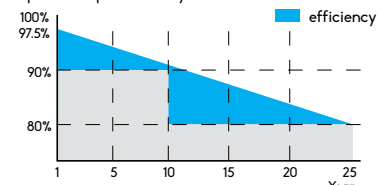



## TECHNICAL DRAWING

### BACK VIEW

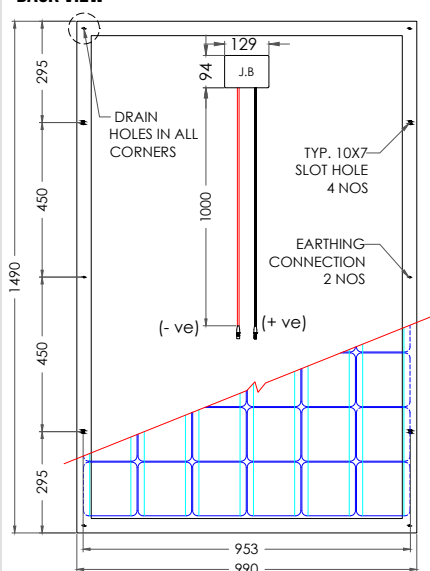

## Series: PM0200-0220-54

### CURRENT VOLTAGE CURVE

PM0200

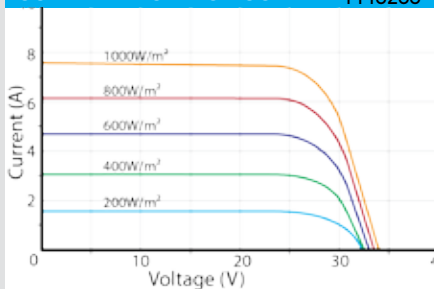

### OPERATING CONDITIONS

Maximum system Voltage - V	1000 VDC
Operating Temperature	- 40 to + 85 °C
Maximum Static Load (Wind/Hail or Snow)	5400 Pa (113 psf)
Maximum series fuse rating (A)	15



PHOTON ENERGY SYSTEMS LIMITED

\* Measured at Standard Test Conditions (STC): Irradiance of 1000W/m<sup>2</sup>, AM 1.5, and Cell temperature 25° C  
 \*\* All Dimensions are in mm.

### PACKAGING DETAILS

No. of Modules per pallet	24
Number of pallets per 40ft container	24

PM0200

PM0210

PM0220

## ELECTRICAL PARAMETERS AT STANDARD TEST CONDITIONS (STC)

	200	210	220
Nominal Power - P <sub>max</sub> (Watts)	200	210	220
Power tolerance (%)	± 2	± 2	± 2
Module Efficiency / Fill Factor (%)	13.5	14.1	14.8
Voltage at Maximum Power - V <sub>mp</sub> (V)	27.05	27.38	27.81
Current at Maximum Power - I <sub>sc</sub> (A)	7.49	7.68	7.97
Open Circuit Voltage - V <sub>oc</sub> (V)	32.29	32.69	33.18
Short Circuit Current - I <sub>sc</sub> (A)	8.20	8.34	8.52

### MODULE DATA

L X W X D (mm)	1490 x 990 x 45
Weight (Kg)	17.5
Area - Sq.m	1.48
Frame Material	Silver White color Anodised Aluminium channel
Glass	3.2 mm Tempered Low Iron Textured toughened glass
Junction Box	Solar Box-RH3, with IP 67 and 3 Bypass diodes ( Make: Huber+ Shuner)
Cable connector	Radox Solar Connectors with 1m length cable (make: Huber +Suhner)
Cell encapsulation material	Ethylene Vinyl Acetate
Backside Sheet	Multi layered PET based film

### CELL DATA

Cell type	Multi-Crystalline
Solar Cells per Module	54
Parent Solar Cell Size	156 x 156

### TEMPERATURE COEFFICIENT

P <sub>max</sub>	- 0.430 % / °C
V <sub>oc</sub>	- 0.330 % / °C
I <sub>sc</sub>	+ 0.058 % / °C

**References:** Specifications included in this datasheet are subject to change without notice. However proper care has been taken to ensure the accuracy of provided data.

**Caution:** Read safety and installation instructions before using this product. This module should not be directly connected to a load.

Photon Energy Systems Limited  
 775-K, Road No. 45, Jubilee Hills,  
 Hyderabad – 500 033, A.P., INDIA  
 Tel: +91 40 2333 1337 / 38 / 39 Fax: +91 40 2333 1340  
 E-mail us: [factory@photonsolar.in](mailto:factory@photonsolar.in) Website: [www.photonsolar.in](http://www.photonsolar.in)



for sales inquiry, email us at [spvmarketing@photonsolar.in](mailto:spvmarketing@photonsolar.in)

for our Dealers Network, kindly visit:  
<http://photonsolar.in/html/dealers-network.html>

# PHOTON ENERGY SYSTEMS LIMITED

Multi - Crystalline

Series: PM0145-0160-36

☎ 1800 4252 786

 [www.fb.com/PhotonSolarPower](http://www.fb.com/PhotonSolarPower)



## ABOUT

Established in 1995, Photon Energy Systems Limited is one of the most experienced solar energy companies in the World. At Photon, we are the leading manufacturers of high performance solar PV modules which are used to power residential, commercial and other large scale utilities. With our highly reliable solar PV modules, produced in a state of the art manufacturing facility, we have installed & commissioned more than 60 MW grid connected power plants in India at the end of fiscal year 2013-14.

To Visit Our Website

## SCAN

with a QR code reader



## PM0150 MODULE



## CELL LAYER DAIGRAM

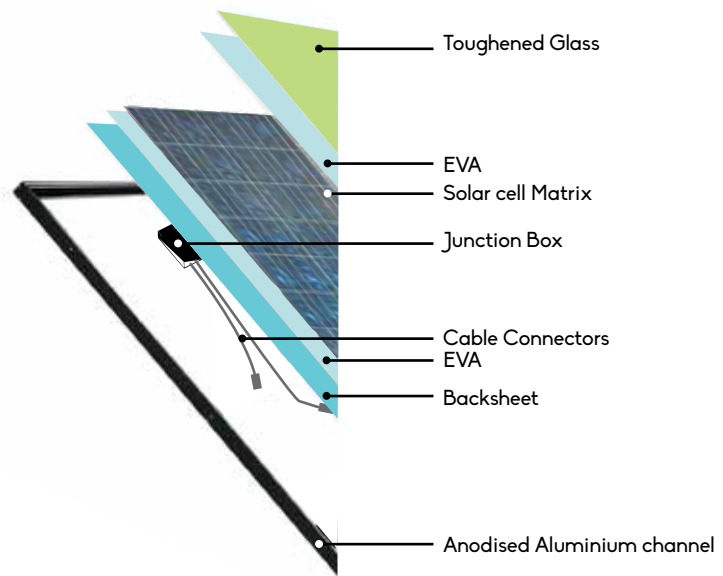

for more details, refer Backpage.

## CERTIFICATIONS & APPROVALS



## AVAILABLE AS PER REQUEST



PID free cells  
(Potential Induced  
Degradation)



RFID Tag  
embedded Modules

## SPECIAL FEATURES

- High energy conversion efficiency because of high fill factor
- Cells sorted by power and current to minimize field mismatch losses.
- Electroluminescence test carried out for micro-cracks



Superior  
25 years Warranty



Certifications: ISO  
9001, ISO 14001



Made in India  
Quality checked



Mechanical Load  
(Wind, Snow) = 5400 Pa



15.2% Module  
Efficiency



Easy Installation  
& Maintenance



Industrial



Commercial



Residential



Rural MicroGrids

10 year product warranty  
25 year power output warranty

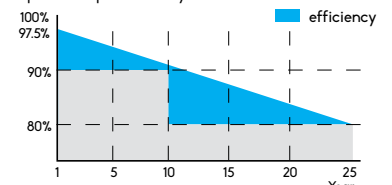

## TECHNICAL DRAWING

### BACK VIEW

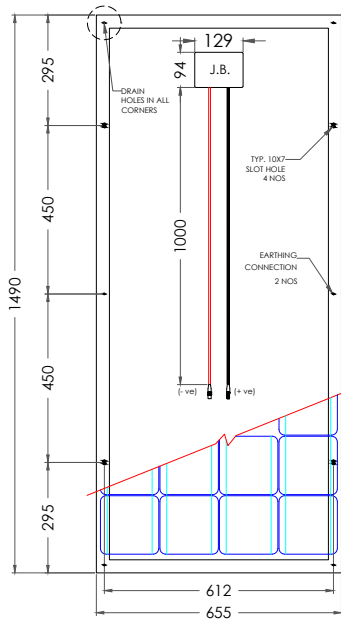

## Series: PM0145-0160-36

### CURRENT VOLTAGE CURVE PM0150

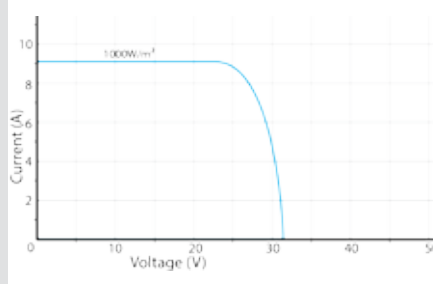

### OPERATING CONDITIONS

Maximum system Voltage - V	1000 VDC
Operating Temperature	- 40 to + 85 °C
Maximum Static Load (Wind/Hail or Snow)	5400 Pa (113 psf)
Maximum series fuse rating (A)	15



PHOTON ENERGY SYSTEMS LIMITED

\* Measured at Standard Test Conditions (STC):  
Irradiance of 1000W/m<sup>2</sup>, AM 1.5, and  
Cell temperature 25° C  
\*\* All Dimensions are in mm.

### PACKAGING DETAILS

No. of Modules per pallet	24
Number of pallets per 40ft container	24

PM0145

PM0150

PM0155

PM0160

## ELECTRICAL PARAMETERS AT STANDARD TEST CONDITIONS (STC)

	PM0145	PM0150	PM0155	PM0160
Nominal Power - P <sub>max</sub> (Watts)	145	150	155	160
Power tolerance (%)	± 2	± 2	± 2	± 2
Module Efficiency / Fill Factor (%)	14.9	15.4	15.6	15.9
Voltage at Maximum Power - V <sub>mp</sub> (V)	18.47	18.62	18.68	18.60
Current at Maximum Power - I <sub>sc</sub> (A)	7.87	8.07	8.48	8.60
Open Circuit Voltage - V <sub>oc</sub> (V)	22.01	22.23	22.57	22.75
Short Circuit Current - I <sub>sc</sub> (A)	8.46	8.58	9.03	9.16

### MODULE DATA

L X W X D (mm)	1490 x 655 x 42
Weight (Kg)	12
Area - Sq.m	0.98
Frame Material	Silver White color Anodised Aluminium channel
Glass	3.2 mm Tempered Low Iron Textured toughened glass
Junction Box	Solar Box-RH3, with IP 67 and 3 Bypass diodes ( Make: Huber+ Shuner)
Cable connector	Radox Solar Connectors with 1m length cable (make: Huber +Suhner)
Cell encapsulation material	Ethylene Vinyl Acetate
Backside Sheet	Multi layered PET based film

### CELL DATA

Cell type	Multi-Crystalline
Solar Cells per Module	36
Parent Solar Cell Size	156 x 156

**References:** Specifications included in this datasheet are subject to change without notice.  
However proper care has been taken to ensure the accuracy of provided data.

**Caution:** Read safety and installation instructions before using this product. This module should not be directly connected to a load.

Photon Energy Systems Limited  
775-K, Road No. 45, Jubilee Hills,  
Hyderabad – 500 033, A.P., INDIA  
Tel: +91 40 2333 1337 / 38 / 39 Fax: +91 40 2333 1340  
E-mail us: [factory@photonsolar.in](mailto:factory@photonsolar.in) Website: [www.photonsolar.in](http://www.photonsolar.in)



for sales inquiry, email us at [spvmarketing@photonsolar.in](mailto:spvmarketing@photonsolar.in)

for our Dealers Network, kindly visit:  
<http://photonsolar.in/html/dealers-network.html>

# PHOTON ENERGY SYSTEMS LIMITED

Multi - Crystalline

Series: PM0125-0140-36

☎ 1800 4252 786

 [www.fb.com/PhotonSolarPower](http://www.fb.com/PhotonSolarPower)



## ABOUT

Established in 1995, Photon Energy Systems Limited is one of the most experienced solar energy companies in the World. At Photon, we are the leading manufacturers of high performance solar PV modules which are used to power residential, commercial and other large scale utilities. With our highly reliable solar PV modules, produced in a state of the art manufacturing facility, we have installed & commissioned more than 60 MW grid connected power plants in India at the end of fiscal year 2013-14.

To Visit Our Website

## SCAN

with a QR code reader



## PM0125 MODULE



## CELL LAYER DAIGRAM

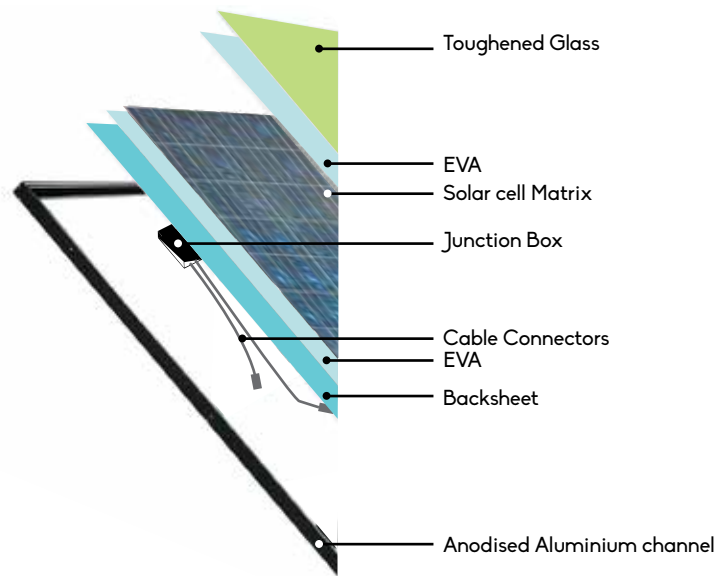

for more details, refer Backpage.

## CERTIFICATIONS & APPROVALS



## AVAILABLE AS PER REQUEST



RFID Tag embedded Modules

## SPECIAL FEATURES

- High energy conversion efficiency because of high fill factor
- Cells sorted by power and current to minimize field mismatch losses.
- Electroluminescence test carried out for micro-cracks



Superior  
25 years Warranty



Certifications: ISO  
9001, ISO 14001



Made in India  
Quality checked



Mechanical Load  
(Wind, Snow) = 5400 Pa



15.2% Module  
Efficiency



Easy Installation  
& Maintainece



Industrial



Commercial



Residential



Rural MicroGrids

10 year product warranty  
25 year power output warranty

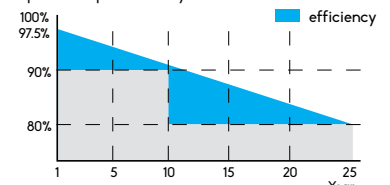

## TECHNICAL DRAWING

### BACK VIEW

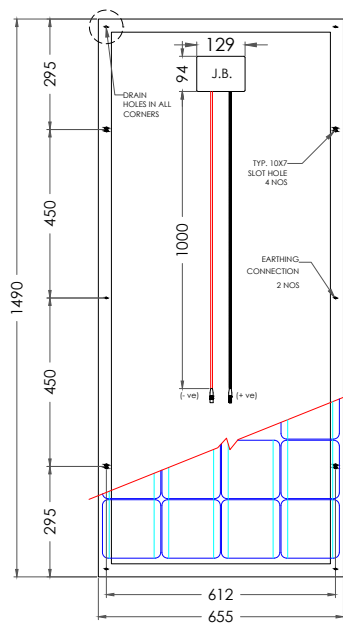

## Series: PM0125-0140-36

### CURRENT VOLTAGE CURVE PM0150

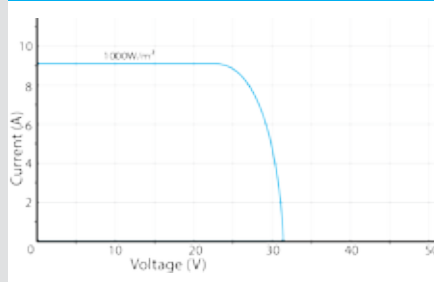

### OPERATING CONDITIONS

Maximum system Voltage - V	1000 VDC
Operating Temperature	- 40 to + 85 °C
Maximum Static Load (Wind/Hail or Snow)	5400 Pa (113 psf)
Maximum series fuse rating (A)	15



PHOTON ENERGY SYSTEMS LIMITED

\* Measured at Standard Test Conditions (STC):  
Irradiance of 1000W/m<sup>2</sup>, AM 1.5, and  
Cell temperature 25° C  
\*\* All Dimensions are in mm.

### PACKAGING DETAILS

No. of Modules per pallet	24
Number of pallets per 40ft container	24

PM0125

PM0130

PM0135

PM0140

## ELECTRICAL PARAMETERS AT STANDARD TEST CONDITIONS (STC)

	125	130	135	140
Nominal Power - P <sub>max</sub> (Watts)	125	130	135	140
Power tolerance (%)	± 2	± 2	± 2	± 2
Module Efficiency / Fill Factor (%)	12.8	13.3	13.8	14.3
Voltage at Maximum Power - V <sub>mp</sub> (V)	17.67	17.86	18.04	18.25
Current at Maximum Power - I <sub>sc</sub> (A)	7.16	7.29	7.49	7.68
Open Circuit Voltage - V <sub>oc</sub> (V)	21.53	21.24	21.53	21.80
Short Circuit Current - I <sub>sc</sub> (A)	7.69	8.10	8.22	8.34

## MODULE DATA

L X W X D (mm)	1490 x 655 x 42
Weight (Kg)	12
Area - Sq.m	0.98
Frame Material	Silver White color Anodised Aluminium channel
Glass	3.2 mm Tempered Low Iron Textured toughened glass
Junction Box	Solar Box-RH3, with IP 67 and 3 Bypass diodes ( Make: Huber+ Shuner)
Cable connector	Radox Solar Connectors with 1m length cable (make: Huber +Suhner)
Cell encapsulation material	Ethylene Vinyl Acetate
Backside Sheet	Multi layered PET based film

## CELL DATA

Cell type	Multi-Crystalline
Solar Cells per Module	36
Parent Solar Cell Size	156 x 156

**References:** Specifications included in this datasheet are subject to change without notice.  
However proper care has been taken to ensure the accuracy of provided data.

**Caution:** Read safety and installation instructions before using this product. This module should not be directly connected to a load.

Photon Energy Systems Limited  
775-K, Road No. 45, Jubilee Hills,  
Hyderabad – 500 033, A.P., INDIA  
Tel: +91 40 2333 1337 / 38 / 39 Fax: +91 40 2333 1340  
E-mail us: [factory@photonsolar.in](mailto:factory@photonsolar.in) Website: [www.photonsolar.in](http://www.photonsolar.in)



for sales inquiry, email us at [spvmarketing@photonsolar.in](mailto:spvmarketing@photonsolar.in)

for our Dealers Network, kindly visit:  
<http://photonsolar.in/html/dealers-network.html>

# PHOTON ENERGY SYSTEMS LIMITED

Multi - Crystalline

Series: PM0100-0120-36

☎ 1800 4252 786

 [www.fb.com/PhotonSolarPower](http://www.fb.com/PhotonSolarPower)



## ABOUT

Established in 1995, Photon Energy Systems Limited is one of the most experienced solar energy companies in the World. At Photon, we are the leading manufacturers of high performance solar PV modules which are used to power residential, commercial and other large scale utilities. With our highly reliable solar PV modules, produced in a state of the art manufacturing facility, we have installed & commissioned more than 60 MW grid connected power plants in India at the end of fiscal year 2013-14.

To Visit Our Website

## SCAN

with a QR code reader



## PM0115 MODULE



## CELL LAYER DAIGRAM

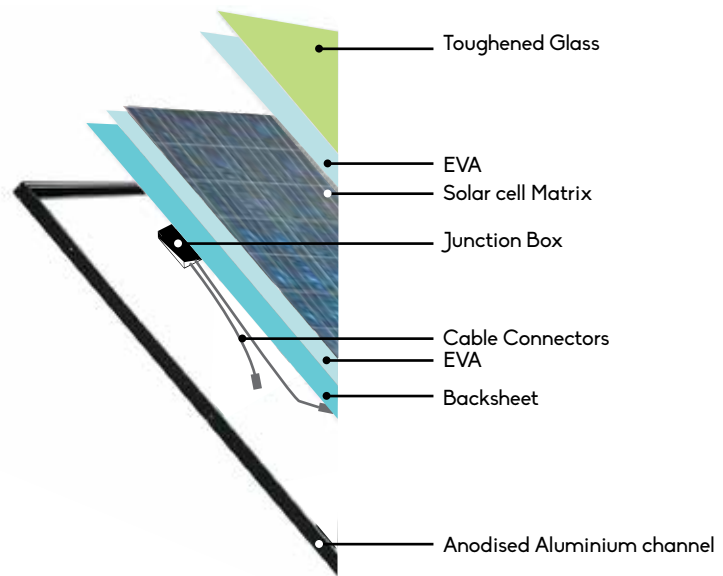

for more details, refer Backpage.

## CERTIFICATIONS & APPROVALS



## AVAILABLE AS PER REQUEST



RFID Tag embedded Modules

## SPECIAL FEATURES

- High energy conversion efficiency because of high fill factor
- Cells sorted by power and current to minimize field mismatch losses.
- Electroluminescence test carried out for micro-cracks



Superior  
25 years Warranty



Certifications: ISO  
9001, ISO 14001



Made in India  
Quality checked



Mechanical Load  
(Wind, Snow) = 5400 Pa



15.2% Module  
Efficiency



Easy Installation  
& Maintainece



Industrial



Commercial



Residential



Rural MicroGrids

10 year product warranty  
25 year power output warranty

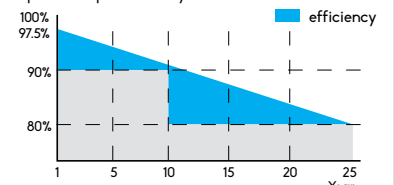

## TECHNICAL DRAWING

### BACK VIEW

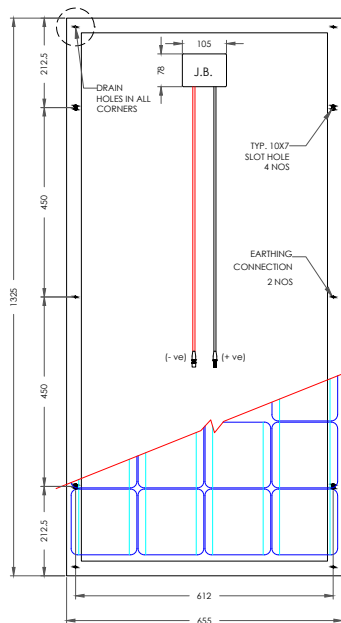

## Series: PM0100-0120-36

### CURRENT VOLTAGE CURVE PM0110

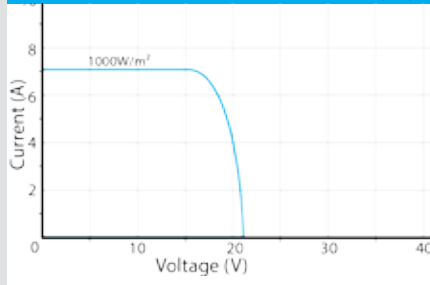

### OPERATING CONDITIONS

Maximum system Voltage - V	1000 VDC
Operating Temperature	- 40 to + 85 °C
Maximum Static Load (Wind/Hail or Snow)	5400 Pa (113 psf)
Maximum series fuse rating (A)	15



PHOTON ENERGY SYSTEMS LIMITED

\* Measured at Standard Test Conditions (STC):  
Irradiance of 1000W/m<sup>2</sup>, AM 1.5, and  
Cell temperature 25° C  
\*\* All Dimensions are in mm.

### PACKAGING DETAILS

No. of Modules per pallet	24
Number of pallets per 40ft container	24

PM0100

PM0110

PM0115

PM0120

## ELECTRICAL PARAMETERS AT STANDARD TEST CONDITIONS (STC)

	100	110	115	120
Nominal Power - P <sub>max</sub> (Watts)	100	110	115	120
Power tolerance (%)	± 2	± 2	± 2	± 2
Module Efficiency / Fill Factor (%)	12	12.8	13.4	13.9
Voltage at Maximum Power - V <sub>mp</sub> (V)	17.70	17.70	17.70	17.70
Current at Maximum Power - I <sub>sc</sub> (A)	5.65	6.20	6.50	6.80
Open Circuit Voltage - V <sub>oc</sub> (V)	21.60	21.60	21.60	21.60
Short Circuit Current - I <sub>sc</sub> (A)	6.34	7.00	7.30	7.60

### MODULE DATA

L X W X D (mm)	1325 x 655 x 35
Weight (Kg)	10.8
Area - Sq.m	0.87
Frame Material	Silver White color Anodised Aluminium channel
Glass	3.2 mm Tempered Low Iron Textured toughened glass
Junction Box	Solar Box-RH3, with IP 67 and 3 Bypass diodes ( Make: Huber+ Shuner)
Cable connector	Radox Solar Connectors with 1m length cable (make: Huber +Suhner)
Cell encapsulation material	Ethylene Vinyl Acetate
Backside Sheet	Multi layered PET based film

### CELL DATA

Cell type	Multi-Crystalline
Solar Cells per Module	36
Parent Solar Cell Size	156 x 156

**References:** Specifications included in this datasheet are subject to change without notice.  
However proper care has been taken to ensure the accuracy of provided data.

**Caution:** Read safety and installation instructions before using this product. This module should not be directly connected to a load.

Photon Energy Systems Limited  
775-K, Road No. 45, Jubilee Hills,  
Hyderabad – 500 033, A.P., INDIA  
Tel: +91 40 2333 1337 / 38 / 39 Fax: +91 40 2333 1340  
E-mail us: [factory@photonsolar.in](mailto:factory@photonsolar.in) Website: [www.photonsolar.in](http://www.photonsolar.in)



for sales inquiry, email us at [spvmarketing@photonsolar.in](mailto:spvmarketing@photonsolar.in)

for our Dealers Network, kindly visit:  
<http://photonsolar.in/html/dealers-network.html>

# PHOTON ENERGY SYSTEMS LIMITED

Multi - Crystalline

Series: PM075-090-36

☎ 1800 4252 786

 [www.fb.com/PhotonSolarPower](http://www.fb.com/PhotonSolarPower)



## ABOUT

Established in 1995, Photon Energy Systems Limited is one of the most experienced solar energy companies in the World. At Photon, we are the leading manufacturers of high performance solar PV modules which are used to power residential, commercial and other large scale utilities. With our highly reliable solar PV modules, produced in a state of the art manufacturing facility, we have installed & commissioned more than 60 MW grid connected power plants in India at the end of fiscal year 2013-14.

To Visit Our Website  
**SCAN**  
with a QR code reader



## PM075 MODULE



## CELL LAYER DAIGRAM

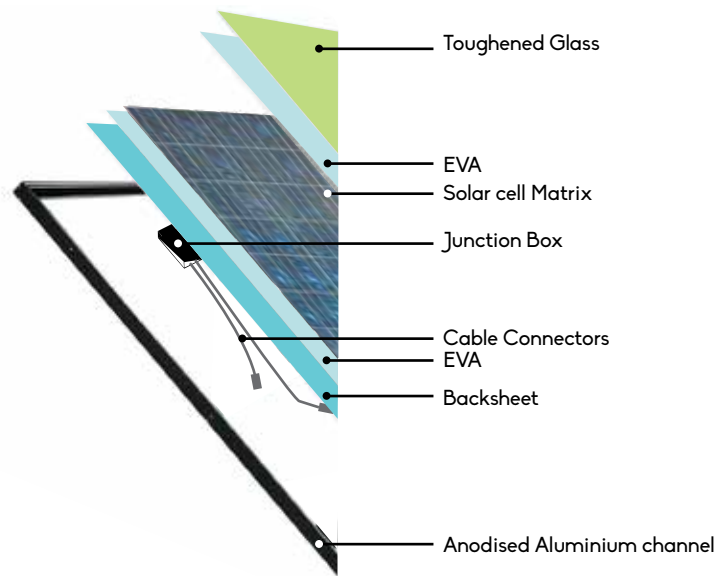

for more details, refer Backpage.

## CERTIFICATIONS & APPROVALS



## AVAILABLE AS PER REQUEST



RFID Tag embedded Modules

## SPECIAL FEATURES

- High energy conversion efficiency because of high fill factor
- Cells sorted by power and current to minimize field mismatch losses.
- Electroluminescence test carried out for micro-cracks



Superior  
25 years Warranty



Certifications: ISO  
9001, ISO 14001



Made in India  
Quality checked



Mechanical Load  
(Wind, Snow) = 5400 Pa



15.2% Module  
Efficiency



Easy Installation  
& Maintainence



Industrial



Commercial



Residential



Rural MicroGrids

10 year product warranty  
25 year power output warranty

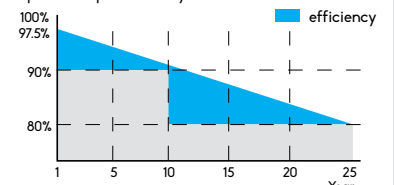



## TECHNICAL DRAWING

### BACK VIEW

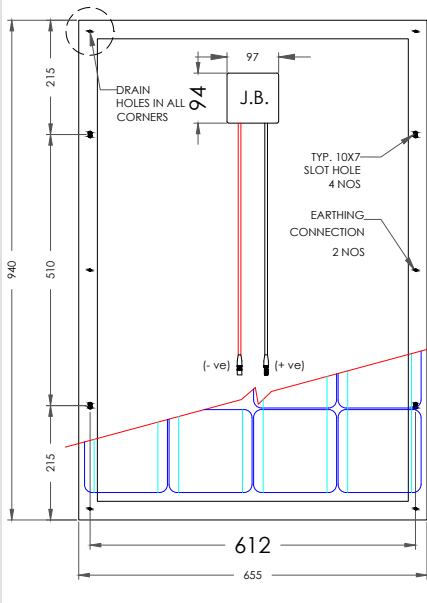

## Series: PM075-090-36

### CURRENT VOLTAGE CURVE PM075

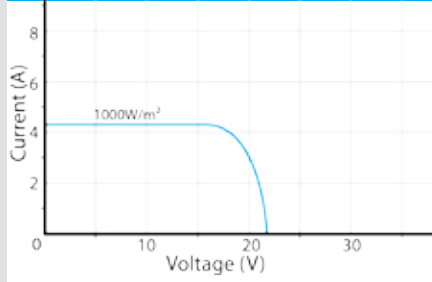

### OPERATING CONDITIONS

Maximum system Voltage - V	1000 VDC
Operating Temperature	- 40 to + 85 °C
Maximum Static Load (Wind/Hail or Snow)	5400 Pa (113 psf)
Maximum series fuse rating (A)	15



PHOTON ENERGY SYSTEMS LIMITED

\* Measured at Standard Test Conditions (STC):  
Irradiance of 1000W/m<sup>2</sup>, AM 1.5, and  
Cell temperature 25° C  
\*\* All Dimensions are in mm.

### PACKAGING DETAILS

No. of Modules per pallet	24
Number of pallets per 40ft container	24

PM0075

PM0080

PM0085

PM0090

### ELECTRICAL PARAMETERS AT STANDARD TEST CONDITIONS (STC)

	75	80	85	90
Nominal Power - P <sub>max</sub> (Watts)	75	80	85	90
Power tolerance (%)	± 2	± 2	± 2	± 2
Module Efficiency / Fill Factor (%)	14	14.2	14.4	14.6
Voltage at Maximum Power - V <sub>mp</sub> (V)	17.70	17.70	17.70	17.70
Current at Maximum Power - I <sub>sc</sub> (A)	4.23	4.52	4.80	5.10
Open Circuit Voltage - V <sub>oc</sub> (V)	21.60	21.60	21.60	21.60
Short Circuit Current - I <sub>sc</sub> (A)	4.75	5.10	5.40	5.70

### MODULE DATA

L X W X D (mm)	940 x 655 x 35
Weight (Kg)	8.4
Area - Sq.m	0.67
Frame Material	Silver White color Anodised Aluminium channel
Glass	3.2 mm Tempered Low Iron Textured toughened glass
Junction Box	Solar Box-RH3, with IP 67 and 3 Bypass diodes ( Make: Huber+ Shuner)
Cable connector	Radox Solar Connectors with 1m length cable (make: Huber +Suhner)
Cell encapsulation material	Ethylene Vinyl Acetate
Backside Sheet	Multi layered PET based film

### CELL DATA

Cell type	Multi-Crystalline
Solar Cells per Module	<b>36</b>
Parent Solar Cell Size	156 x 156

**References:** Specifications included in this datasheet are subject to change without notice.  
However proper care has been taken to ensure the accuracy of provided data.

**Caution:** Read safety and installation instructions before using this product. This module should not be directly connected to a load.

Photon Energy Systems Limited  
775-K, Road No. 45, Jubilee Hills,  
Hyderabad – 500 033, A.P., INDIA  
Tel: +91 40 2333 1337 / 38 / 39 Fax: +91 40 2333 1340  
E-mail us: [factory@photonsolar.in](mailto:factory@photonsolar.in) Website: [www.photonsolar.in](http://www.photonsolar.in)



for sales inquiry, email us at [spvmarketing@photonsolar.in](mailto:spvmarketing@photonsolar.in)

for our Dealers Network, kindly visit:  
<http://photonsolar.in/html/dealers-network.html>

# PHOTON ENERGY SYSTEMS LIMITED

Multi - Crystalline

Series: PM060-070-36

☎ 1800 4252 786

 [www.fb.com/PhotonSolarPower](http://www.fb.com/PhotonSolarPower)



## ABOUT

Established in 1995, Photon Energy Systems Limited is one of the most experienced solar energy companies in the World. At Photon, we are the leading manufacturers of high performance solar PV modules which are used to power residential, commercial and other large scale utilities. With our highly reliable solar PV modules, produced in a state of the art manufacturing facility, we have installed & commissioned more than 60 MW grid connected power plants in India at the end of fiscal year 2013-14.

To Visit Our Website

## SCAN

with a QR code reader



## PM070 MODULE



## CELL LAYER DAIGRAM

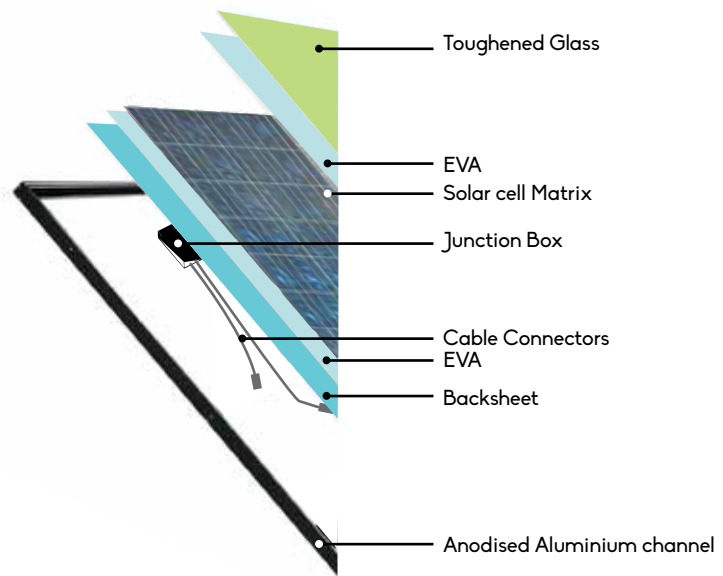

for more details, refer Backpage.

## CERTIFICATIONS & APPROVALS



## AVAILABLE AS PER REQUEST



RFID Tag embedded Modules

## SPECIAL FEATURES

- High energy conversion efficiency because of high fill factor
- Cells sorted by power and current to minimize field mismatch losses.
- Electroluminescence test carried out for micro-cracks



Superior  
25 years Warranty



Certifications: ISO  
9001, ISO 14001



Made in India  
Quality checked



Mechanical Load  
(Wind, Snow) = 5400 Pa



15.2% Module  
Efficiency



Easy Installation  
& Maintainece



Industrial



Commercial



Residential



Rural MicroGrids

10 year product warranty  
25 year power output warranty

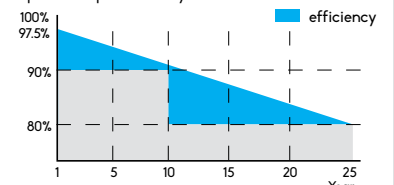

## TECHNICAL DRAWING

### BACK VIEW

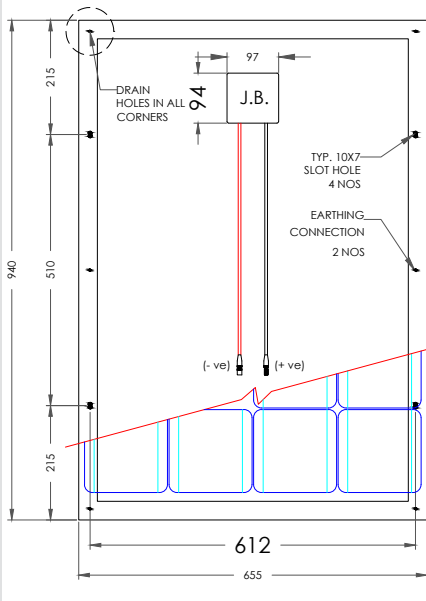

## Series: PM060-070-36

### CURRENT VOLTAGE CURVE PM075

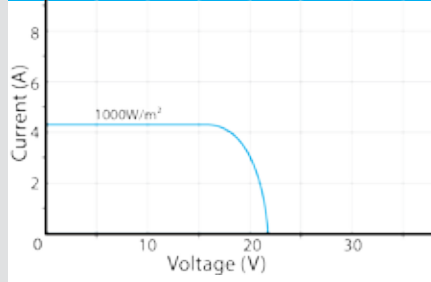

### OPERATING CONDITIONS

Maximum system Voltage - V	1000 VDC
Operating Temperature	- 40 to + 85 °C
Maximum Static Load (Wind/Hail or Snow)	5400 Pa (113 psf)
Maximum series fuse rating (A)	15



PHOTON ENERGY SYSTEMS LIMITED

\* Measured at Standard Test Conditions (STC):  
Irradiance of 1000W/m<sup>2</sup>, AM 1.5, and  
Cell temperature 25° C  
\*\* All Dimensions are in mm.

### PACKAGING DETAILS

No. of Modules per pallet	24
Number of pallets per 40ft container	24

PM0060

PM0065

PM0070

## ELECTRICAL PARAMETERS AT STANDARD TEST CONDITIONS (STC)

	60	65	70
Nominal Power - P <sub>max</sub> (Watts)	60	65	70
Power tolerance (%)	± 2	± 2	± 2
Module Efficiency / Fill Factor (%)	13.1	13.5	13.8
Voltage at Maximum Power - V <sub>mp</sub> (V)	17.70	17.70	17.70
Current at Maximum Power - I <sub>sc</sub> (A)	3.40	3.67	3.95
Open Circuit Voltage - V <sub>oc</sub> (V)	21.60	21.60	21.60
Short Circuit Current - I <sub>sc</sub> (A)	3.80	4.12	4.43

## MODULE DATA

L X W X D (mm)	940 x 655 x 35
Weight (Kg)	8.4
Area - Sq.m	0.67
Frame Material	Silver White color Anodised Aluminium channel
Glass	3.2 mm Tempered Low Iron Textured toughened glass
Junction Box	Solar Box-RH3, with IP 67 and 3 Bypass diodes ( Make: Huber+ Shuner)
Cable connector	Radox Solar Connectors with 1m length cable (make: Huber +Suhner)
Cell encapsulation material	Ethylene Vinyl Acetate
Backside Sheet	Multi layered PET based film

## CELL DATA

Cell type	Multi-Crystalline
Solar Cells per Module	36
Parent Solar Cell Size	156 x 156

**References:** Specifications included in this datasheet are subject to change without notice.  
However proper care has been taken to ensure the accuracy of provided data.

**Caution:** Read safety and installation instructions before using this product. This module should not be directly connected to a load.

Photon Energy Systems Limited  
775-K, Road No. 45, Jubilee Hills,  
Hyderabad – 500 033, A.P., INDIA  
Tel: +91 40 2333 1337 / 38 / 39 Fax: +91 40 2333 1340  
E-mail us: [factory@photonsolar.in](mailto:factory@photonsolar.in) Website: [www.photonsolar.in](http://www.photonsolar.in)



for sales inquiry, email us at [spvmarketing@photonsolar.in](mailto:spvmarketing@photonsolar.in)

for our Dealers Network, kindly visit:  
<http://photonsolar.in/html/dealers-network.html>

# PHOTON ENERGY SYSTEMS LIMITED

Multi - Crystalline

Series: PM045-055-36

☎ 1800 4252 786

 [www.fb.com/PhotonSolarPower](http://www.fb.com/PhotonSolarPower)



## ABOUT

Established in 1995, Photon Energy Systems Limited is one of the most experienced solar energy companies in the World. At Photon, we are the leading manufacturers of high performance solar PV modules which are used to power residential, commercial and other large scale utilities. With our highly reliable solar PV modules, produced in a state of the art manufacturing facility, we have installed & commissioned more than 60 MW grid connected power plants in India at the end of fiscal year 2013-14.

To Visit Our Website

## SCAN

with a QR code reader



## PM050 MODULE

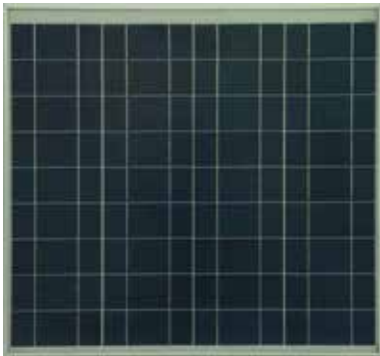

## CELL LAYER DAIGRAM

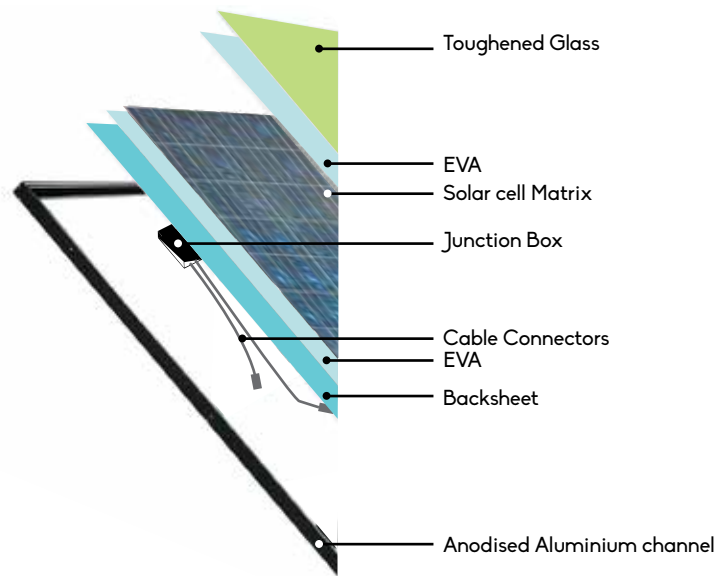

for more details, refer Backpage.

## CERTIFICATIONS & APPROVALS



## AVAILABLE AS PER REQUEST



RFID Tag embedded Modules

## SPECIAL FEATURES

- High energy conversion efficiency because of high fill factor
- Cells sorted by power and current to minimize field mismatch losses.
- Electroluminescence test carried out for micro-cracks



Superior  
25 years Warranty



Certifications: ISO  
9001, ISO 14001



Made in India  
Quality checked



Mechanical Load  
(Wind, Snow) = 5400 Pa



15.2% Module  
Efficiency



Easy Installation  
& Maintainece



Industrial



Commercial



Residential



Rural MicroGrids

10 year product warranty  
25 year power output warranty

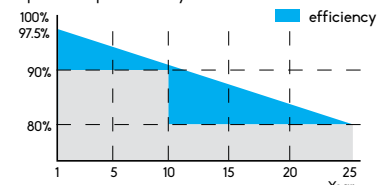

## TECHNICAL DRAWING

### BACK VIEW

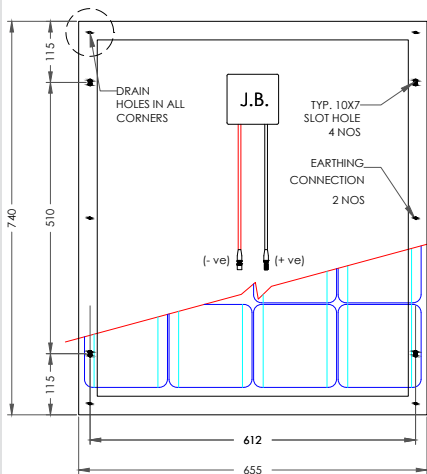

## Series: PM045-055-36

### CURRENT VOLTAGE CURVE PM050

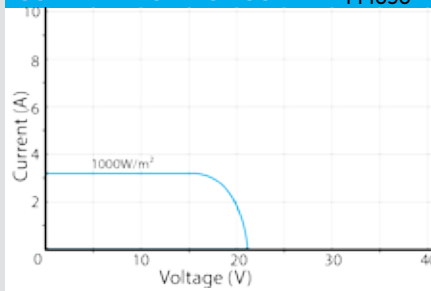

### OPERATING CONDITIONS

Maximum system Voltage - V	1000 VDC
Operating Temperature	- 40 to + 85 °C
Maximum Static Load (Wind/Hail or Snow)	5400 Pa (113 psf)
Maximum series fuse rating (A)	15



PHOTON ENERGY SYSTEMS LIMITED

\* Measured at Standard Test Conditions (STC):  
Irradiance of 1000W/m<sup>2</sup>, AM 1.5, and  
Cell temperature 25° C  
\*\* All Dimensions are in mm.

### PACKAGING DETAILS

No. of Modules per pallet	24
Number of pallets per 40ft container	24

PM0045

PM0050

PM0055

### ELECTRICAL PARAMETERS AT STANDARD TEST CONDITIONS (STC)

	45	50	55
Nominal Power - P <sub>max</sub> (Watts)	45	50	55
Power tolerance (%)	± 2	± 2	± 2
Module Efficiency / Fill Factor (%)	11	11.2	12.2
Voltage at Maximum Power - V <sub>mp</sub> (V)	17.70	17.70	17.70
Current at Maximum Power - I <sub>sc</sub> (A)	2.54	2.82	3.10
Open Circuit Voltage - V <sub>oc</sub> (V)	21.60	21.60	21.60
Short Circuit Current - I <sub>sc</sub> (A)	2.85	3.17	3.48

### MODULE DATA

L X W X D (mm)	740 x 655 x 35
Weight (Kg)	6.9
Area - Sq.m	0.48
Frame Material	Silver White color Anodised Aluminium channel
Glass	3.2 mm Tempered Low Iron Textured toughened glass
Junction Box	Solar Box-RH3, with IP 67 and 3 Bypass diodes ( Make: Huber+ Shuner)
Cable connector	Radox Solar Connectors with 1m length cable (make: Huber +Suhner)
Cell encapsulation material	Ethylene Vinyl Acetate
Backside Sheet	Multi layered PET based film

### CELL DATA

Cell type	Multi-Crystalline
Solar Cells per Module	36
Parent Solar Cell Size	156 x 156

**References:** Specifications included in this datasheet are subject to change without notice. However proper care has been taken to ensure the accuracy of provided data.

**Caution:** Read safety and installation instructions before using this product. This module should not be directly connected to a load.

Photon Energy Systems Limited  
775-K, Road No. 45, Jubilee Hills,  
Hyderabad – 500 033, A.P., INDIA  
Tel: +91 40 2333 1337 / 38 / 39 Fax: +91 40 2333 1340  
E-mail us: [factory@photonsolar.in](mailto:factory@photonsolar.in) Website: [www.photonsolar.in](http://www.photonsolar.in)



for sales inquiry, email us at [spvmarketing@photonsolar.in](mailto:spvmarketing@photonsolar.in)

for our Dealers Network, kindly visit:  
<http://photonsolar.in/html/dealers-network.html>

# PHOTON ENERGY SYSTEMS LIMITED

Multi - Crystalline

Series: PM030-040-36

☎ 1800 4252 786

 [www.fb.com/PhotonSolarPower](http://www.fb.com/PhotonSolarPower)



## ABOUT

Established in 1995, Photon Energy Systems Limited is one of the most experienced solar energy companies in the World. At Photon, we are the leading manufacturers of high performance solar PV modules which are used to power residential, commercial and other large scale utilities. With our highly reliable solar PV modules, produced in a state of the art manufacturing facility, we have installed & commissioned more than 60 MW grid connected power plants in India at the end of fiscal year 2013-14.

To Visit Our Website

## SCAN

with a QR code reader



## PM037 MODULE



## CELL LAYER DAIGRAM

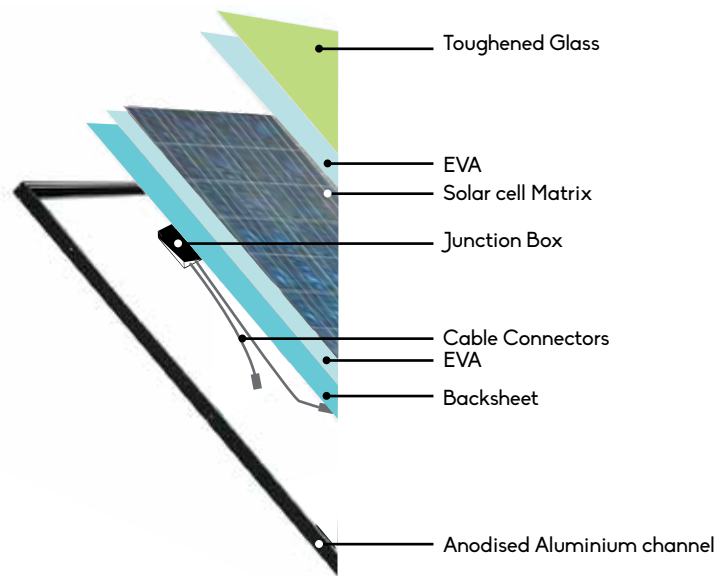

for more details, refer Backpage.

## CERTIFICATIONS & APPROVALS



## AVAILABLE AS PER REQUEST



RFID Tag embedded Modules

## SPECIAL FEATURES

- High energy conversion efficiency because of high fill factor
- Cells sorted by power and current to minimize field mismatch losses.
- Electroluminescence test carried out for micro-cracks



Superior  
25 years Warranty



Certifications: ISO  
9001, ISO 14001



Made in India  
Quality checked



Mechanical Load  
(Wind, Snow) = 5400 Pa



15.2% Module  
Efficiency



Easy Installation  
& Maintenance



Industrial



Commercial



Residential



Rural MicroGrids

10 year product warranty  
25 year power output warranty

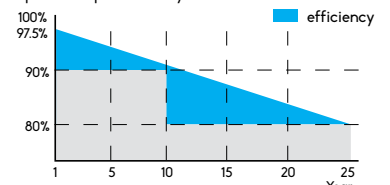

## TECHNICAL DRAWING

### BACK VIEW

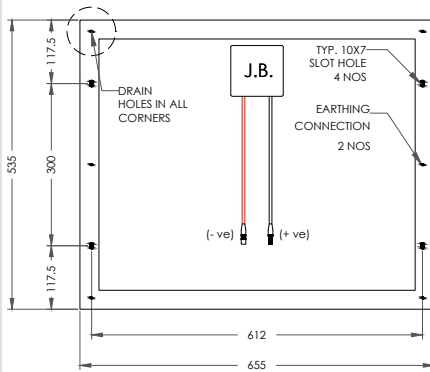

## Series: PM030-040-36

### CURRENT VOLTAGE CURVE PM037

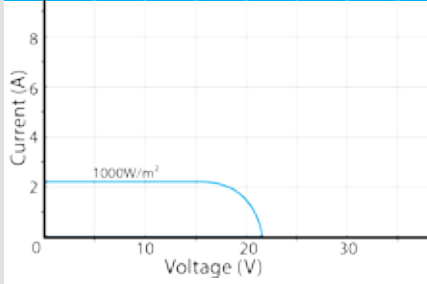

### OPERATING CONDITIONS

Maximum system Voltage - V	1000 VDC
Operating Temperature	- 40 to + 85 °C
Maximum Static Load (Wind/Hail or Snow)	5400 Pa (113 psf)
Maximum series fuse rating (A)	15



PHOTON ENERGY SYSTEMS LIMITED

\* Measured at Standard Test Conditions (STC):  
Irradiance of 1000W/m<sup>2</sup>, AM 1.5, and  
Cell temperature 25° C  
\*\* All Dimensions are in mm.

### PACKAGING DETAILS

No. of Modules per pallet	24
Number of pallets per 40ft container	24

PM0030

PM0035

PM0037

PM0040

## ELECTRICAL PARAMETERS AT STANDARD TEST CONDITIONS (STC)

	30	35	37	40
Nominal Power - P <sub>max</sub> (Watts)	30	35	37	40
Power tolerance (%)	± 2	± 2	± 2	± 2
Module Efficiency / Fill Factor (%)	11	11.4	11.8	11.9
Voltage at Maximum Power - V <sub>mp</sub> (V)	17.70	17.70	17.70	17.70
Current at Maximum Power - I <sub>sc</sub> (A)	1.70	1.98	2.10	2.30
Open Circuit Voltage - V <sub>oc</sub> (V)	21.60	21.60	21.60	21.60
Short Circuit Current - I <sub>sc</sub> (A)	1.93	2.20	2.34	2.53

### MODULE DATA

L X W X D (mm)	535 x 655 x 35
Weight (Kg)	4.2
Area - Sq.m	0.35
Frame Material	Silver White color Anodised Aluminium channel
Glass	3.2 mm Tempered Low Iron Textured toughened glass
Junction Box	Solar Box-RH3, with IP 67 and 3 Bypass diodes ( Make: Huber+ Shuner)
Cable connector	Radox Solar Connectors with 1m length cable (make: Huber +Suhner)
Cell encapsulation material	Ethylene Vinyl Acetate
Backside Sheet	Multi layered PET based film

### CELL DATA

Cell type	Multi-Crystalline
Solar Cells per Module	36
Parent Solar Cell Size	156 x 156

**References:** Specifications included in this datasheet are subject to change without notice. However proper care has been taken to ensure the accuracy of provided data.

**Caution:** Read safety and installation instructions before using this product. This module should not be directly connected to a load.

Photon Energy Systems Limited  
775-K, Road No. 45, Jubilee Hills,  
Hyderabad – 500 033, A.P., INDIA  
Tel: +91 40 2333 1337 / 38 / 39 Fax: +91 40 2333 1340  
E-mail us: [factory@photonsolar.in](mailto:factory@photonsolar.in) Website: [www.photonsolar.in](http://www.photonsolar.in)



for sales inquiry, email us at [spvmarketing@photonsolar.in](mailto:spvmarketing@photonsolar.in)

for our Dealers Network, kindly visit:  
<http://photonsolar.in/html/dealers-network.html>

# PHOTON ENERGY SYSTEMS LIMITED

Multi - Crystalline

Model - PM020

☎ 1800 4252 786

 [www.fb.com/PhotonSolarPower](http://www.fb.com/PhotonSolarPower)



## ABOUT

Established in 1995, Photon Energy Systems Limited is one of the most experienced solar energy companies in the World. At Photon, we are the leading manufacturers of high performance solar PV modules which are used to power residential, commercial and other large scale utilities. With our highly reliable solar PV modules, produced in a state of the art manufacturing facility, we have installed & commissioned more than 60 MW grid connected power plants in India at the end of fiscal year 2013-14.

To Visit Our Website  
**SCAN**  
with a QR code reader



## PM0020 MODULE

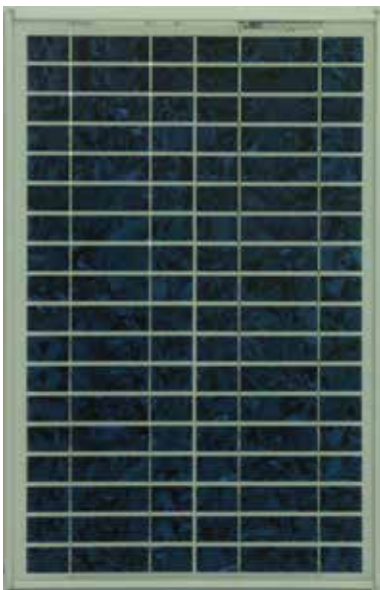

## CELL LAYER DAIGRAM

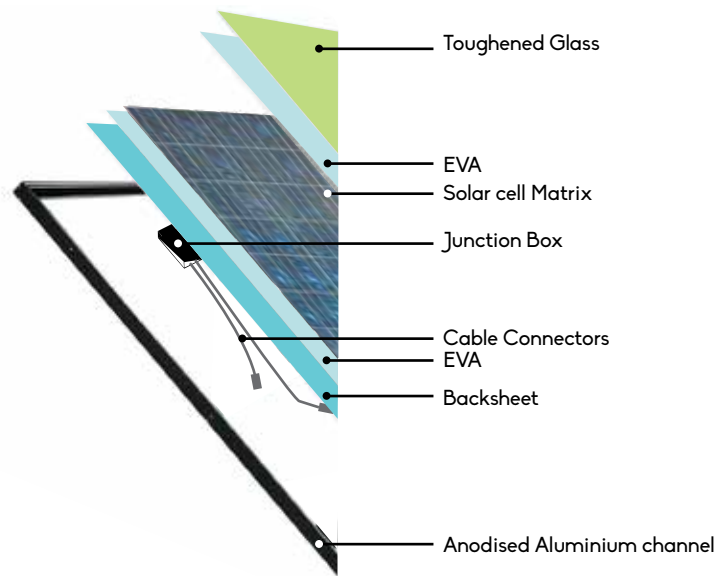

for more details, refer Backpage.

## CERTIFICATIONS & APPROVALS



## AVAILABLE AS PER REQUEST



RFID Tag embedded Modules

## SPECIAL FEATURES

- High energy conversion efficiency because of high fill factor
- Cells sorted by power and current to minimize field mismatch losses.
- Electroluminescence test carried out for micro-cracks



Superior  
25 years Warranty



Certifications: ISO  
9001, ISO 14001



Made in India  
Quality checked



Mechanical Load  
(Wind, Snow) = 5400 Pa



15.2% Module  
Efficiency



Easy Installation  
& Maintainece



Industrial



Commercial



Residential



Rural MicroGrids

10 year product warranty  
25 year power output warranty

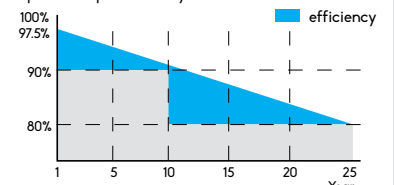



## TECHNICAL DRAWING

### BACK VIEW

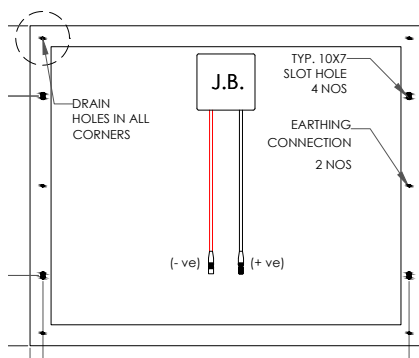

## Model - PM020

### CURRENT VOLTAGE CURVE PM0020

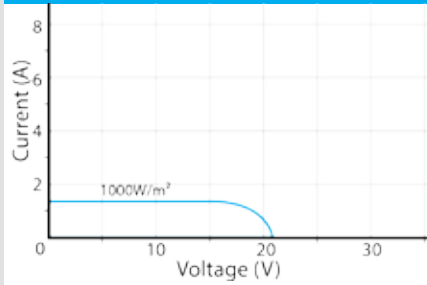

### OPERATING CONDITIONS

Maximum system Voltage - V	1000 VDC
Operating Temperature	- 40 to + 85 °C
Maximum Static Load (Wind/Hail or Snow)	5400 Pa (113 psf)
Maximum series fuse rating (A)	15



PHOTON ENERGY SYSTEMS LIMITED

\* Measured at Standard Test Conditions (STC):  
Irradiance of 1000W/m<sup>2</sup>, AM 1.5, and  
Cell temperature 25° C  
\*\* All Dimensions are in mm.

### PACKAGING DETAILS

No. of Modules per pallet	24
Number of pallets per 40ft container	24

## ELECTRICAL PARAMETERS AT STANDARD TEST CONDITIONS (STC)

Nominal Power - P <sub>max</sub> (Watts)	<b>20</b>
Power tolerance (%)	± 2
Module Efficiency / Fill Factor (%)	13.6
Voltage at Maximum Power - V <sub>mp</sub> (V)	17.70
Current at Maximum Power - I <sub>sc</sub> (A)	1.13
Open Circuit Voltage - V <sub>oc</sub> (V)	21.60
Short Circuit Current - I <sub>sc</sub> (A)	1.30

## MODULE DATA

L X W X D (mm)	540 x 355 x 22
Weight (Kg)	2
Area - Sq.m	0.19
Frame Material	Silver White color Anodised Aluminium channel
Glass	3.2 mm Tempered Low Iron Textured toughened glass
Junction Box	Solar Box-RH3, with IP 67 and 3 Bypass diodes ( Make: Huber+ Shuner)
Cable connector	Radox Solar Connectors with 1m length cable (make: Huber +Suhner)
Cell encapsulation material	Ethylene Vinyl Acetate
Backside Sheet	Multi layered PET based film

## CELL DATA

Cell type	Multi-Crystalline
Solar Cells per Module	<b>36 (9 x 4)</b>
Parent Solar Cell Size	156 x 156

**References:** Specifications included in this datasheet are subject to change without notice.  
However proper care has been taken to ensure the accuracy of provided data.

**Caution:** Read safety and installation instructions before using this product. This module should not be directly connected to a load.

Photon Energy Systems Limited  
775-K, Road No. 45, Jubilee Hills,  
Hyderabad – 500 033, A.P., INDIA  
Tel: +91 40 2333 1337 / 38 / 39 Fax: +91 40 2333 1340  
E-mail us: [factory@photonsolar.in](mailto:factory@photonsolar.in) Website: [www.photonsolar.in](http://www.photonsolar.in)



for sales inquiry, email us at [spvmarketing@photonsolar.in](mailto:spvmarketing@photonsolar.in)

for our Dealers Network, kindly visit:  
<http://photonsolar.in/html/dealers-network.html>

# PHOTON ENERGY SYSTEMS LIMITED

Multi - Crystalline

Model - PM010

☎ 1800 4252 786

 [www.fb.com/PhotonSolarPower](http://www.fb.com/PhotonSolarPower)



## ABOUT

Established in 1995, Photon Energy Systems Limited is one of the most experienced solar energy companies in the World. At Photon, we are the leading manufacturers of high performance solar PV modules which are used to power residential, commercial and other large scale utilities. With our highly reliable solar PV modules, produced in a state of the art manufacturing facility, we have installed & commissioned more than 60 MW grid connected power plants in India at the end of fiscal year 2013-14.

To Visit Our Website  
**SCAN**  
with a QR code reader



## PM010 MODULE

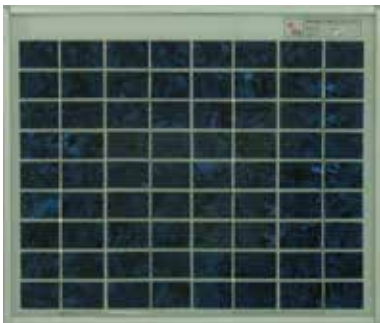

## CELL LAYER DAIGRAM

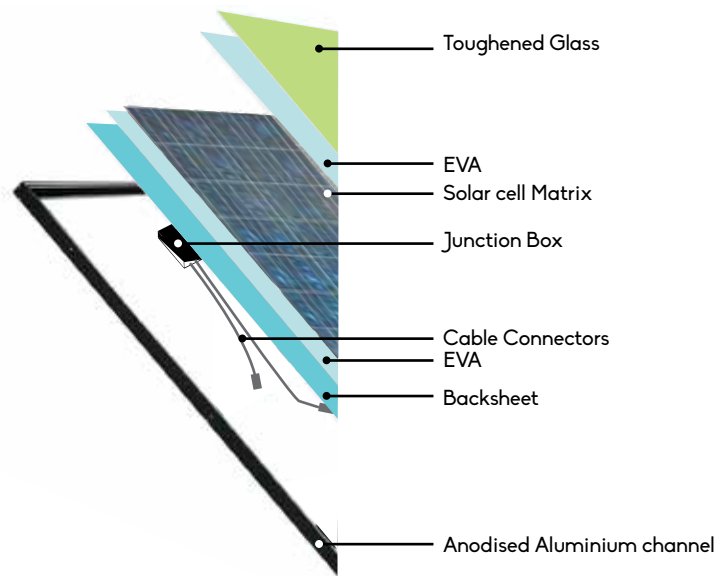

for more details, refer Backpage.

## CERTIFICATIONS & APPROVALS



## AVAILABLE AS PER REQUEST



RFID Tag embedded Modules

## SPECIAL FEATURES

- High energy conversion efficiency because of high fill factor
- Cells sorted by power and current to minimize field mismatch losses.
- Electroluminescence test carried out for micro-cracks



Superior  
25 years Warranty



Certifications: ISO  
9001, ISO 14001



Made in India  
Quality checked



Mechanical Load  
(Wind, Snow) = 5400 Pa



15.2% Module  
Efficiency



Easy Installation  
& Maintainece



Industrial



Commercial



Residential



Rural MicroGrids

10 year product warranty  
25 year power output warranty

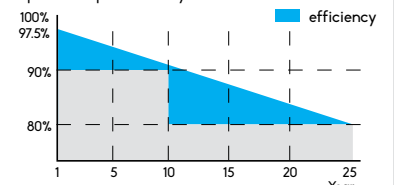

## TECHNICAL DRAWING

### BACK VIEW

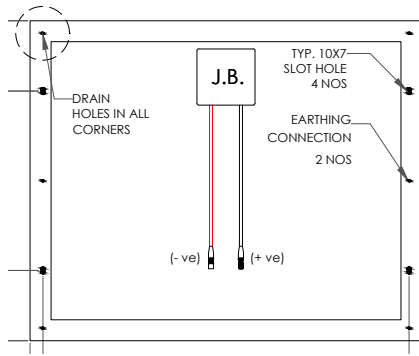

## Model - PM010

### CURRENT VOLTAGE CURVE PM010

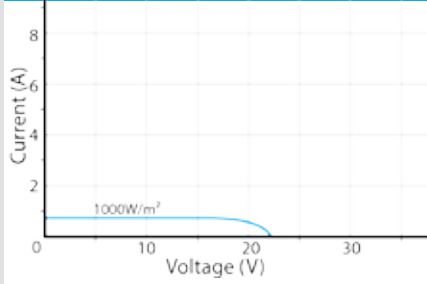

### OPERATING CONDITIONS

Maximum system Voltage - V	1000 VDC
Operating Temperature	- 40 to + 85 °C
Maximum Static Load (Wind/Hail or Snow)	5400 Pa (113 psf)
Maximum series fuse rating (A)	15



PHOTON ENERGY SYSTEMS LIMITED

\* Measured at Standard Test Conditions (STC):  
Irradiance of 1000W/m<sup>2</sup>, AM 1.5, and  
Cell temperature 25° C  
\*\* All Dimensions are in mm.

### PACKAGING DETAILS

No. of Modules per pallet	24
Number of pallets per 40ft container	24

## ELECTRICAL PARAMETERS AT STANDARD TEST CONDITIONS (STC)

Nominal Power - P <sub>max</sub> (Watts)	10
Power tolerance (%)	± 2
Module Efficiency / Fill Factor (%)	11
Voltage at Maximum Power - V <sub>mp</sub> (V)	17.70
Current at Maximum Power - I <sub>sc</sub> (A)	0.56
Open Circuit Voltage - V <sub>oc</sub> (V)	21.60
Short Circuit Current - I <sub>sc</sub> (A)	0.64

## MODULE DATA

L X W X D (mm)	295 x 355 x 22
Weight (Kg)	0.7
Area - Sq.m	0.06
Frame Material	Silver White color Anodised Aluminium channel
Glass	3.2 mm Tempered Low Iron Textured toughened glass
Junction Box	Solar Box-RH3, with IP 67 and 3 Bypass diodes ( Make: Huber+ Shuner)
Cable connector	Radox Solar Connectors with 1m length cable (make: Huber +Suhner)
Cell encapsulation material	Ethylene Vinyl Acetate
Backside Sheet	Multi layered PET based film

## CELL DATA

Cell type	Multi-Crystalline
Solar Cells per Module	36 (9 x 4)
Parent Solar Cell Size	156 x 156

**References:** Specifications included in this datasheet are subject to change without notice.  
However proper care has been taken to ensure the accuracy of provided data.

**Caution:** Read safety and installation instructions before using this product. This module should not be directly connected to a load.

Photon Energy Systems Limited  
775-K, Road No. 45, Jubilee Hills,  
Hyderabad – 500 033, A.P., INDIA  
Tel: +91 40 2333 1337 / 38 / 39 Fax: +91 40 2333 1340  
E-mail us: [factory@photonsolar.in](mailto:factory@photonsolar.in) Website: [www.photonsolar.in](http://www.photonsolar.in)



for sales inquiry, email us at [spvmarketing@photonsolar.in](mailto:spvmarketing@photonsolar.in)

for our Dealers Network, kindly visit:  
<http://photonsolar.in/html/dealers-network.html>

# PHOTON ENERGY SYSTEMS LIMITED

Multi - Crystalline

Model - PM005

☎ 1800 4252 786

 [www.fb.com/PhotonSolarPower](http://www.fb.com/PhotonSolarPower)



## ABOUT

Established in 1995, Photon Energy Systems Limited is one of the most experienced solar energy companies in the World. At Photon, we are the leading manufacturers of high performance solar PV modules which are used to power residential, commercial and other large scale utilities. With our highly reliable solar PV modules, produced in a state of the art manufacturing facility, we have installed & commissioned more than 60 MW grid connected power plants in India at the end of fiscal year 2013-14.

To Visit Our Website  
**SCAN**  
with a QR code reader



## PM005 MODULE

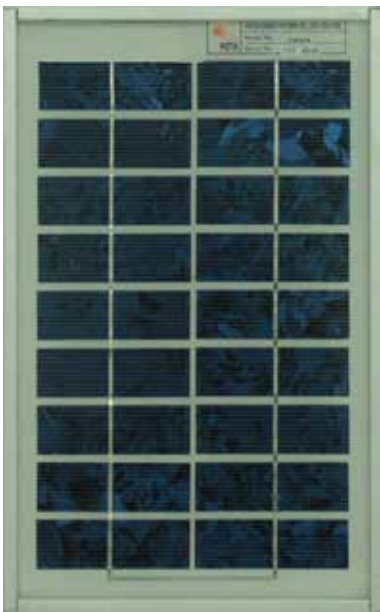

## CELL LAYER DAIGRAM

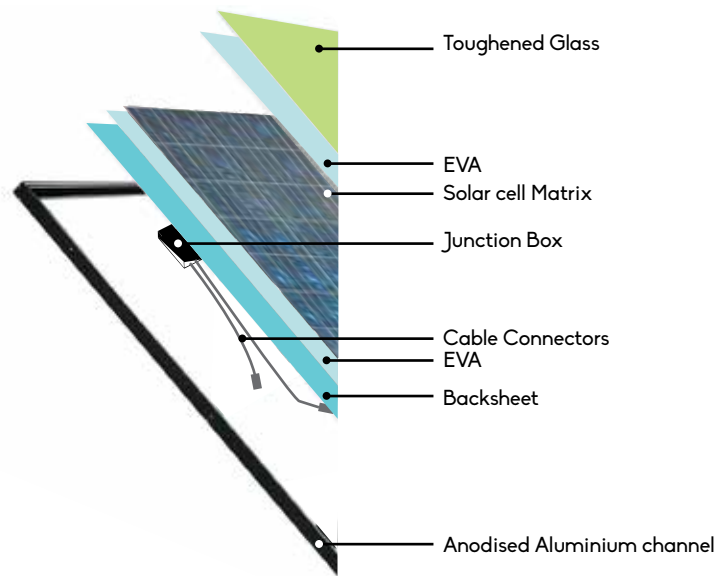

for more details, refer Backpage.

## CERTIFICATIONS & APPROVALS



## AVAILABLE AS PER REQUEST



RFID Tag embedded Modules

## SPECIAL FEATURES

- High energy conversion efficiency because of high fill factor
- Cells sorted by power and current to minimize field mismatch losses.
- Electroluminescence test carried out for micro-cracks



Superior  
25 years Warranty



Certifications: ISO  
9001, ISO 14001



Made in India  
Quality checked



Mechanical Load  
(Wind, Snow) = 5400 Pa



15.2% Module  
Efficiency



Easy Installation  
& Maintainece



Industrial



Commercial



Residential



Rural MicroGrids

10 year product warranty  
25 year power output warranty

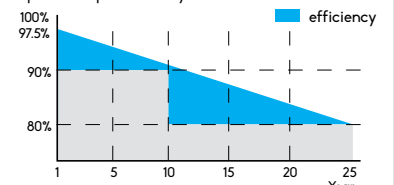

## TECHNICAL DRAWING

### BACK VIEW

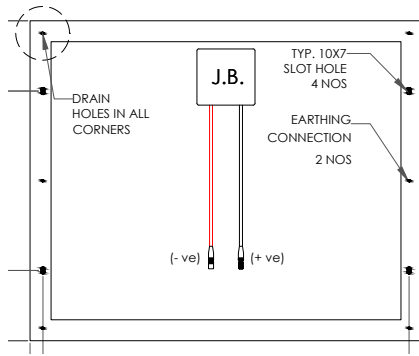

## Model - PM005

### CURRENT VOLTAGE CURVE PM005

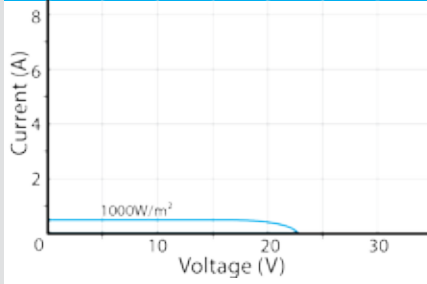

### OPERATING CONDITIONS

Maximum system Voltage - V	1000 VDC
Operating Temperature	- 40 to + 85 °C
Maximum Static Load (Wind/Hail or Snow)	5400 Pa (113 psf)
Maximum series fuse rating (A)	15



PHOTON ENERGY SYSTEMS LIMITED

\* Measured at Standard Test Conditions (STC):  
Irradiance of 1000W/m<sup>2</sup>, AM 1.5, and  
Cell temperature 25° C  
\*\* All Dimensions are in mm.

### PACKAGING DETAILS

No. of Modules per pallet	24
Number of pallets per 40ft container	24

## ELECTRICAL PARAMETERS AT STANDARD TEST CONDITIONS (STC)

Nominal Power - P <sub>max</sub> (Watts)	5
Power tolerance (%)	± 2
Module Efficiency / Fill Factor (%)	9
Voltage at Maximum Power - V <sub>mp</sub> (V)	17.70
Current at Maximum Power - I <sub>sc</sub> (A)	0.28
Open Circuit Voltage - V <sub>oc</sub> (V)	21.60
Short Circuit Current - I <sub>sc</sub> (A)	0.32

## MODULE DATA

L X W X D (mm)	310 x 195 x 22
Weight (Kg)	0.7
Area - Sq.m	0.06
Frame Material	Silver White color Anodised Aluminium channel
Glass	3.2 mm Tempered Low Iron Textured toughened glass
Junction Box	Solar Box-RH3, with IP 67 and 3 Bypass diodes ( Make: Huber+ Shuner)
Cable connector	Radox Solar Connectors with 1m length cable (make: Huber +Suhner)
Cell encapsulation material	Ethylene Vinyl Acetate
Backside Sheet	Multi layered PET based film

## CELL DATA

Cell type	Multi-Crystalline
Solar Cells per Module	<b>36 (9 x 4)</b>
Parent Solar Cell Size	156 x 156

**References:** Specifications included in this datasheet are subject to change without notice.  
However proper care has been taken to ensure the accuracy of provided data.

**Caution:** Read safety and installation instructions before using this product. This module should not be directly connected to a load.

Photon Energy Systems Limited  
775-K, Road No. 45, Jubilee Hills,  
Hyderabad – 500 033, A.P., INDIA  
Tel: +91 40 2333 1337 / 38 / 39 Fax: +91 40 2333 1340  
E-mail us: [factory@photonsolar.in](mailto:factory@photonsolar.in) Website: [www.photonsolar.in](http://www.photonsolar.in)



for sales inquiry, email us at [spvmarketing@photonsolar.in](mailto:spvmarketing@photonsolar.in)

for our Dealers Network, kindly visit:  
<http://photonsolar.in/html/dealers-network.html>

# PHOTON ENERGY SYSTEMS LIMITED

Multi - Crystalline

Model - PM003

☎ 1800 4252 786

 [www.fb.com/PhotonSolarPower](http://www.fb.com/PhotonSolarPower)



## ABOUT

Established in 1995, Photon Energy Systems Limited is one of the most experienced solar energy companies in the World. At Photon, we are the leading manufacturers of high performance solar PV modules which are used to power residential, commercial and other large scale utilities. With our highly reliable solar PV modules, produced in a state of the art manufacturing facility, we have installed & commissioned more than 60 MW grid connected power plants in India at the end of fiscal year 2013-14.

To Visit Our Website

## SCAN

with a QR code reader



## PM003 MODULE



## CELL LAYER DAIGRAM

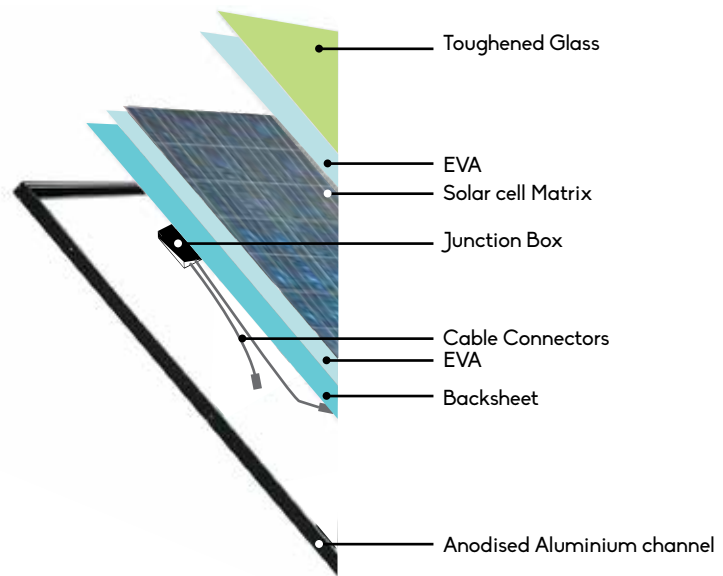

for more details, refer Backpage.

## CERTIFICATIONS & APPROVALS



## AVAILABLE AS PER REQUEST



RFID Tag embedded Modules

## SPECIAL FEATURES

- High energy conversion efficiency because of high fill factor
- Cells sorted by power and current to minimize field mismatch losses.
- Electroluminescence test carried out for micro-cracks



Superior  
25 years Warranty



Certifications: ISO  
9001, ISO 14001



Made in India  
Quality checked



Mechanical Load  
(Wind, Snow) = 5400 Pa



15.2% Module  
Efficiency



Easy Installation  
& Maintainece



Industrial



Commercial



Residential



Rural MicroGrids

10 year product warranty  
25 year power output warranty

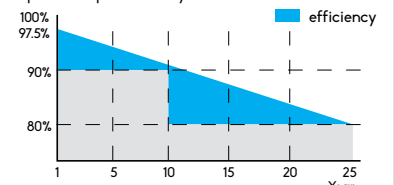

## TECHNICAL DRAWING

### BACK VIEW

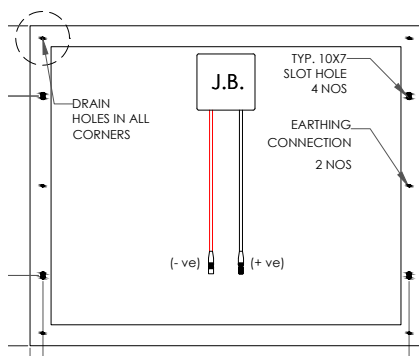

## Model - PM003

### CURRENT VOLTAGE CURVE PM003

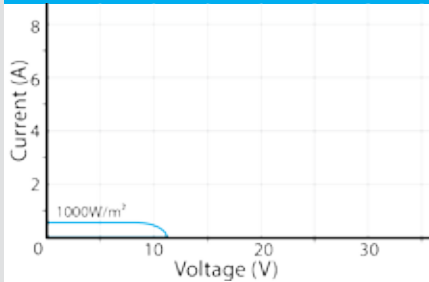

### OPERATING CONDITIONS

Maximum system Voltage - V	1000 VDC
Operating Temperature	- 40 to + 85 °C
Maximum Static Load (Wind/Hail or Snow)	5400 Pa (113 psf)
Maximum series fuse rating (A)	15



PHOTON ENERGY SYSTEMS LIMITED

\* Measured at Standard Test Conditions (STC):  
Irradiance of 1000W/m<sup>2</sup>, AM 1.5, and  
Cell temperature 25° C  
\*\* All Dimensions are in mm.

### PACKAGING DETAILS

No. of Modules per pallet	24
Number of pallets per 40ft container	24

## ELECTRICAL PARAMETERS AT STANDARD TEST CONDITIONS (STC)

Nominal Power - P <sub>max</sub> (Watts)	<b>3</b>
Power tolerance (%)	± 2
Module Efficiency / Fill Factor (%)	9
Voltage at Maximum Power - V <sub>mp</sub> (V)	8.2
Current at Maximum Power - I <sub>sc</sub> (A)	0.37
Open Circuit Voltage - V <sub>oc</sub> (V)	10
Short Circuit Current - I <sub>sc</sub> (A)	0.42

## MODULE DATA

L X W X D (mm)	230 x 195 x 22
Weight (Kg)	0.6
Area - Sq.m	0.045
Frame Material	Silver White color Anodised Aluminium channel
Glass	3.2 mm Tempered Low Iron Textured toughened glass
Junction Box	Solar Box-RH3, with IP 67 and 3 Bypass diodes ( Make: Huber+ Shuner)
Cable connector	Radox Solar Connectors with 1m length cable (make: Huber +Suhner)
Cell encapsulation material	Ethylene Vinyl Acetate
Backside Sheet	Multi layered PET based film

## CELL DATA

Cell type	Multi-Crystalline
Solar Cells per Module	<b>18 (6 x 3)</b>
Parent Solar Cell Size	156 x 156

**References:** Specifications included in this datasheet are subject to change without notice.  
However proper care has been taken to ensure the accuracy of provided data.

**Caution:** Read safety and installation instructions before using this product. This module should not be directly connected to a load.

Photon Energy Systems Limited  
775-K, Road No. 45, Jubilee Hills,  
Hyderabad – 500 033, A.P., INDIA  
Tel: +91 40 2333 1337 / 38 / 39 Fax: +91 40 2333 1340  
E-mail us: [factory@photonsolar.in](mailto:factory@photonsolar.in) Website: [www.photonsolar.in](http://www.photonsolar.in)



for sales inquiry, email us at [spvmarketing@photonsolar.in](mailto:spvmarketing@photonsolar.in)

for our Dealers Network, kindly visit:  
<http://photonsolar.in/html/dealers-network.html>